

APPENDIX J

UGW#350010

SOUTH WASTE ROCK RECLAMATION PERMIT MODIFICATION APPLICATION

South Waste Rock Reclamation Project

Groundwater Discharge Permit UGW350010 Modification

Water Collection System Design
Bingham Canyon Mine and Water Collection System



November 2014

Kennecott Utah Copper LLC

Kennecott Utah Copper
4700 Daybreak Parkway
South Jordan, Utah 84095
801-569-2128 (o)
801-569-7192 (f)

Chris Kaiser
Manager - Environment

November 19, 2014

Mr. Dan Hall, Section Manager
Groundwater Protection Section
Division of Water Quality
Utah Department of Environmental Quality
195 West 1950 North
P.O. Box 144870
Salt Lake City, Utah 84114-4870

Dear Mr. Hall:

Subject: **Groundwater Discharge Permit Modification Application
South Waste Rock Reclamation
Bingham Canyon Mine and Water Collection System, Permit # UGW350010**

Kennecott Utah Copper LLC (KUC) submits for Utah Division of Water Quality (UDWQ) review and approval for this groundwater discharge permit modification application referred to as the South Waste Rock Reclamation project. The modification is specific to the water collection system south and east of the Mine's waste rock piles and will entail a major modification to the system in order to accommodate waste rock placement and modification of the existing water collection system. Attached to this letter is the groundwater discharge permit modification application and applicable supplemental documents compiled to support the permit modification as listed:

1. Utah Groundwater Discharge Permit Application
2. Attachment 1, Supplemental Hydrogeological Report
3. Attachment 2, Groundwater Discharge Control Plan
4. Attachment 3, Compliance Monitoring Plan
5. Groundwater Discharge Permit UGW350010 and Statement of Basis (in track changes to capture project modifications and renewal updates)

Not included with the application are modified Contingency and Corrective Action Plan or Closure and Post Closure Plan. These plans currently exist within the existing groundwater discharge permit # UGW350010 and remain relevant under the proposed permit modification.

In conjunction with this permit modification application; KUC has or is in the process of submitting under separate cover letters 1) various sets of construction drawings and specifications for DWQ review and approval, and 2) permit modifications coinciding with the 2015 permit renewal process.

Should the division have any questions regarding this submittal or require additional information during the review please contact Scott Wheeler, Sr. Advisor – Water Quality, at (801) 569.7817.

Sincerely,



Chris Kaiser
Manager – Environment

Cc: Woody Campbell (DWQ)
Brian Hamos (DWQ)
Doug Bacon (DERR)

RioTinto

Bcc:
Steve Schnoor
Thiess Lindsay
Zeb Kenyon
Dave Hales
Jared Barlow
Matt Lengerich
Paula Doughty
Glenn Eurick
Brian Vinton
Scott Wheeler
Ian Schofield
Reed Bodell
Jason Doyle
Chad Baker

MAIL TO:
Division of Water Quality
Utah Department of Environmental Quality
Salt Lake City, Utah 84114-4870

Application No.: _____
Date Received: _____
(leave both lines blank)

UTAH GROUNDWATER DISCHARGE PERMIT APPLICATION

Part A - General Facility Information

Please read and follow carefully the instructions on this application form. Please type or print, except for signatures. This application is to be submitted by the owner or operator of a facility having one or more discharges to groundwater. The application must be signed by an official facility representative who is: the owner, sole proprietor for a sole proprietorship, a general partner, an executive officer of at least the level of vice president for a corporation, or an authorized representative of such executive officer having overall responsibility for the operation of the facility.

- 1. Administrative Information.** Enter the information requested in the space provided below, including the name, title and telephone number of an agent at the facility who can answer questions regarding this application.

Facility Name: Kennecott Utah Copper LLC Bingham Canyon Mine and Water Collection System

Mail Address: 4700 Daybreak Parkway, South Jordan, Utah 84095
(Number & Street, Box and/or Route, City, State, Zip Code)

Facility Legal Location* See Attachment 1, Figure 1-1 County: Salt Lake

Bingham Canyon Mine and Water Collection System

T. 3 South, R. 2 West, Portions of Sec. 17, 18, 19, 20, 21, 29, 30, 31, 32

T. 3 South, R. 3 West, Portions of Sec. 11, 12, 13, 14, 22, 23, 24, 25, 26, 27, 33, 34, 35, 36

T. 4 South, R. 2 West, Portions of Sec. 6, 7

T. 4 South, R. 3 West, Portions of Sec. 1, 2, 3, 9, 11, 12

South Waste Rock Reclamation (SWRR)

T. 3 South, R. 2 West, Portion of Sec. 31, T 3 South, R. 3 West, Portion of Sec. 36, T. 4 South, R. 2 West, Portion of Sec. 6, T. 4 South, R. 4 West, Portion of Sec. 1

*Note: A topographic map or detailed aerial photograph should be used in conjunction with a written description to depict the location of the facility, points of groundwater discharge, and other relevant features/objects.

Contact's Name: Scott Wheeler Phone No.: (801) 569-7817

Title: Senior Advisor – Water Quality

- 2. Owner/Operator Information.** Enter the information requested below, including the name, title, and phone number of the official representative signing the application.

Owner

Name: Kennecott Utah Copper LLC Phone No.: (801)204-2000

Mail Address: 4700 Daybreak Parkway, South Jordan, Utah 84095
(Number & Street, Box and/or Route, City, State, Zip Code)

Operator

Name: Same Phone No. _____
(If different than Owner's above)

Mail Address: _____
(Number & Street, Box and/or Route, City, State, Zip Code)

Official Representative

Name: Chris Kaiser Phone No.: (801) 569-2128

Title: Manager - Environment

3. Facility Classification (check one)

- New Facility
- Existing Facility
- Modification of Existing Facility

4. Type of Facility (check one)

- Industrial
- Mining
- Municipal
- Agricultural Operation
- Other, please describe: _____

5. SIC/NAICS Codes: NAICS-212234 SIC-1021

Enter Principal 3 Digit Code Numbers Used in Census & Other Government Reports

6. Projected Facility Life: Permanent

7. Identify principal processes used, or services performed by the facility. Include the principal products produced, and raw materials used by the facility:

Open pit mining which primarily involves the extraction of metal bearing ore (Cu, Au, Ag and Mo) and the storage of overburden.

8. List all existing or pending Federal, State, and Local government environmental permits:

	<u>Permit Number</u>
<input checked="" type="checkbox"/> NPDES or UPDES (discharges to surface water)	<u>UT0000051</u>
<input type="checkbox"/> CAFO (concentrated animal feeding operation)	_____
<input type="checkbox"/> UIC (underground injection of fluids)	_____
<input checked="" type="checkbox"/> RCRA (hazardous waste)	<u>UTD000826404</u>
<input checked="" type="checkbox"/> PDS (air emissions from proposed sources)	<u>DAQE-AN0105710028-11</u>
<input type="checkbox"/> Construction Permit (wastewater treatment)	_____
<input checked="" type="checkbox"/> Solid Waste Permit (sanitary landfills, incinerators)	<u>35-0011803</u>
<input checked="" type="checkbox"/> Septic Tank/Drainfield	<u>LUWDS – KUC Bingham Canyon Mine 6190 Area</u>
<input checked="" type="checkbox"/> Other, specify <u>Mining and Reclamation (DOGM)</u>	<u>M/035/0002</u>

9. Name, location (Lat. _____ ° _____ ‘ _____ “N, Long. _____ ° _____ ‘ _____ “W) and description of: each well/spring (existing, abandoned, or proposed), water usage (past, present, or future); water bodies; drainages; well-head protection areas; drinking water source protection zones according to UAC 309-600; topography; and man-made structures within one mile radius of the point(s) of discharge site. Provide existing well logs (include total depth and variations in water depths).

<u>Name</u>	<u>Location</u>	<u>Description</u>	<u>Status</u>	<u>Usage</u>
<u>See Attachment 1, Table 2-1 (Features [wells and springs] within one mile of facility)</u>				
<u>See Attachment 3, Figure 1-1 (existing monitoring well network)</u>				

The above information must be included on a plat map and attached to the application.

Part B - General Discharge Information

Complete the following information for each point of discharge to groundwater. If more than one discharge point exists, photocopy and complete this Part B form for each discharge point.

1. **Location** (if different than Facility Location in Part A): County: Same as facility location
 T. _____, R. _____, Sec. _____, _____ 1/4 of _____ 1/4,
 Lat. _____ ° _____ ' _____ "N, Long. _____ ° _____ ' _____ "W

2. **Type of fluid to be Discharged or Potentially Discharged**
 (check as applicable)

Discharges (fluids discharged to the ground)

- Sanitary Wastewater: wastewater from restrooms, toilets, showers and the like
- Cooling Water: non-contact cooling water, non-contact of raw materials, intermediate, final, or waste products
- Process Wastewater: wastewater used in or generated by an industrial process
- Mine Water: water from dewatering operations at mines
- Other, specify: _____

Potential Discharges (leachates or other fluids that may discharge to the ground)

- Solid Waste Leachates: leachates from solid waste impoundments or landfills
- Milling/Mining Leachates: tailings impoundments, mine leaching operations, etc.
- Storage Pile Leachates: leachates from storage piles of raw materials, product, or wastes
- Potential Underground Tank Leakage: tanks not regulated by UST or RCRA only
- Other, specify: _____

3. **Discharge Volumes**

For each type of discharge checked in #2 above, list the volumes of wastewater discharged to the ground or groundwater. Volumes of wastewater should be measured or calculated from water usage. If it is necessary to estimate volumes, enclose the number in parentheses. Average daily volume means the average per operating day: ex. For a discharge of 1,000,000 gallons per year from a facility operating 200 days, the average daily volume is 5,000 gallons.

Discharge Type:	Daily Discharge Volume (Average)	all in units of (Maximum)
<u>None</u>	_____	_____
_____	_____	_____

4. **Potential Discharge Volumes**

For each type of potential discharge checked in #2 above, list the maximum volume of fluid that could be discharged to the ground considering such factors as: liner hydraulic conductivity and operating head conditions, leak detection system sensitivity, leachate collection system efficiency, etc. Attach calculation and raw data used to determine said potential discharge. See Attachment 1 (Supplemental Hydrogeology Report, Section 4.3) for seepage calculations.

Discharge Type	Daily Discharge Volume (Average)	All in units of (Maximum)
Potential seepage of waste rock contact water (WRCW) to bedrock	5.9 *	5.9 * GPM

* These estimates are likely biased high because (1) conservative assumptions were used in their calculation, and (2) the South Waste Rock Reclamation System modifications described in Attachment 2 will potentially further reduce formation of WRCW. See section 4.3.2 for details.

5. Means of Discharge or Potential Discharge (check one or more as applicable)

- | | |
|---|---|
| <input type="checkbox"/> lagoon, pit, or surface impoundment (fluids) | <input type="checkbox"/> industrial drainfield |
| <input type="checkbox"/> land application or land treatment | <input type="checkbox"/> underground storage tank |
| <input type="checkbox"/> discharge to an ephemeral drainage
(dry wash, etc.) | <input type="checkbox"/> percolation/infiltration basin |
| <input checked="" type="checkbox"/> storage pile | <input type="checkbox"/> mine heap or dump leach |
| <input type="checkbox"/> landfill (industrial or solid wastes) | <input type="checkbox"/> mine tailings pond |
| <input type="checkbox"/> other, specify _____ | |

6. Flows, Sources of Pollution, and Treatment Technologies

Flows. Attach a line drawing showing: 1) water flow through the facility to the groundwater discharge point, and 2) sources of fluids, wastes, or solids which accumulate at the potential groundwater discharge point. Indicate sources of intake materials or water, operations contributing wastes or wastewater to the effluent, and wastewater treatment units. Construct a water balance on the line drawing by showing average flows between intakes, operations, treatment units, and wastewater outfalls. If a water balance cannot be determined, provide a pictorial description of the nature and amount of any sources of water and any collection or treatment measures. See the following example.

TABLE 6-1
Peak Waste Rock Contact Water Flow by
Drainage (gallons per minute)

Olsen	30
Butterfield 1	11
Castro	124
South Saints Rest	25
Saints Rest	55
Yosemite	60

FIGURE 6-1
Waste Rock Contact Water Flow Diagram

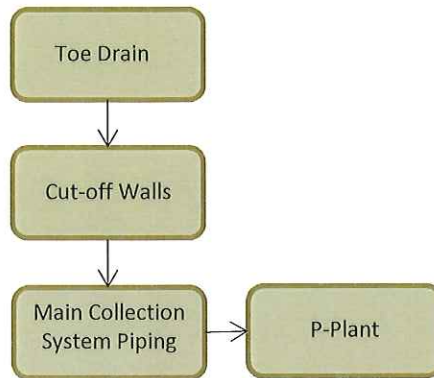

TABLE 6-2
Drainage Basin Flows for the 100-Year, 24-Hour
Storm Event by Drainage (gallons per minute)

Olsen	2,122
Butterfield 1	1,119
Castro	6,745
South Saints Rest	910
Saints Rest	1,382
Yosemite	3,109

FIGURE 6-2
Surface Drainage Flow Diagram



7. Discharge Effluent Characteristics

Established and Proposed Groundwater Quality Standards - Identify wastewater or leachate characteristics by providing the type, source, chemical, physical, radiological, and toxic characteristics of wastewater or leachate to be discharged or potentially discharged to groundwater (with lab analytical data if possible). This should include the discharge rate or combination of discharges, and the expected concentrations of any pollutant (mg/l). If more than one discharge point is used, information for each point must be provided.

Protection levels and compliance limits have been established for compliance wells at the facility. For more detail see Attachment 3 of the permit application or Appendix B of Groundwater Discharge Permit UGW350010

Hazardous Substances - Review the present hazardous substances found in the Clean Water Act, if applicable. List those substances found or believed present in the discharge or potential discharge.

Sulfuric acid and salts of sulfates and chlorides including cadmium, copper and zinc

Part C – Accompanying Reports and Plans

The following reports and plans should be prepared by or under the direction of a professional engineer or other groundwater professional. Since groundwater permits cover a large variety of discharge activities, the appropriate details and requirements of the following reports and plans will be covered in the pre-design meeting(s). For further instruction refer to the Groundwater Permit Application Guidance Document.

8. Hydrogeologic Report (See Attachment 1, Supplemental Hydrogeology Report)

Provide a Geologic Description, with references used, that includes as appropriate:

Structural Geology – regional and local, particularly faults, fractures, joints and bedding plane joints; **Stratigraphy** – geologic formations and thickness, soil types and thickness, depth to bedrock; **Topography** – provide a USGS MAP (7 ½ minute series) which clearly identifies legal site location boundaries, indicated 100 year flood plain area and applicable flood control or drainage barriers and surrounding land uses.

Provide a Hydrologic Description, with references used, that includes:

Groundwater – depths, flow directions and gradients. Well logs should be included if available. Include name of aquifer, saturated thickness, flow directions, porosity, hydraulic conductivity, and other flow characteristics, hydraulic connection with other aquifers or surface sources, recharge information, water in storage, usage, and the projected aerial extent of the aquifer. Should include projected groundwater area of influence affected by the discharge. Provide hydraulic gradient map indicating equal potential head contours and groundwater flow lines. Obtain water elevations of nearby wells at the time of the hydrologic investigation. Collect and analyze groundwater samples from the uppermost aquifer which underlies the discharge point(s). Historic data can be used if the applicant can demonstrate it meets the requirements contained within this section. Collection points should be hydraulically up and down gradient and within a one-mile radius of the discharge point(s). Groundwater analysis should include each element listed in Groundwater Discharge Permit Application, Part B7.

NOTE: Failure to analyze for background concentrations of any contaminant of concern in the discharge or potential discharge may result in the Director's presumptive determination that zero concentration exist in the background groundwater quality.

Sample Collection and Analysis Quality Assurance – sample collection and Preservation must meet the requirements of the EPA RCRA Technical Enforcement Guidance Document, OSWER-9959.1, 1986 [UAC R317-6-6.3(I,6)]. Sample analysis must be performed by State of Utah certified laboratories and be certified for each of the parameters of concern. Analytical methods should be selected from the following sources [UAC R317-6-6.3L]: (Standard Methods for the Examination of Water and Wastewater, 20th Ed., 1998; EPA, Methods for Chemical Analysis of Water and Wastes, 1983; Techniques of Water Resources Investigation of the U.S. Geological Survey, 1998, Book 9; EPA Methods published pursuant to 40 CFR Parts 141, 142, 264 (including Appendix IX), and 270. Analytical methods selected should also include minimum detection limits below both the Groundwater Quality Standards and the anticipated groundwater protection levels. Data shall be presented in accordance of accepted hydrogeologic standards and practice.

Provide Agricultural Description, with references used, that includes:

If agricultural crops are grown within legal boundaries of the site the discussion must include: types of crops produced; soil types present; irrigation system; location of livestock confinement areas (existing or abandoned).

Note on Protection Levels:

After the applicant has defined the quality of the fluid to be discharged (Groundwater Discharge Permit Application, Part B), characterized by the local hydrogeologic conditions and determined background groundwater quality (Hydrogeologic Report), the Director will determine the applicable groundwater class, based on: 1) the location of the discharge point within an area of formally classified groundwater, or the background value of total dissolved solids. Accordingly, the Director will determine applicable protection levels for each pollutant of concern, based on background concentrations and in accordance with UAC R317-6-4.

9. Groundwater Discharge Control Plan: (See Attachment 2, Groundwater Discharge Control Plan)

Select a compliance monitoring method and demonstrate an adequate discharge control system. Listed are some of the Discharge Control Options available.

No Discharge – prevent any discharge of fluids to the groundwater by lining the discharge point with multiple synthetic and clay liners. Such a system would be designed, constructed, and operated to prevent any release of fluids during both the active life and any post-closure period required.

Earthen Liner – control the volume and rate of effluent seepage by lining the discharge point with a low permeability earthen liner (e.g. clay). Then demonstrate that the receiving groundwater, at a point as close as practical to the discharge point, does not or will not exceed the applicable class TDS limits and protection levels* set by the Director. This demonstration should also be based on numerical or analytical saturated or unsaturated groundwater flow and contaminant transport simulations.

Effluent Pretreatment – demonstrate that the quality of the raw or treated effluent at the point of discharge or potential discharge does not or will not exceed the applicable groundwater class TDS limits and protection levels* set by the Director.

Contaminant Transport/Attenuation – demonstrate that due to subsurface contaminant transport mechanisms at the site, raw or treated effluent does not or will not cause the receiving groundwater, at a point as close as possible to the discharge point, to exceed the applicable class TDS limits and protection levels* set by the Director.

Other Methods – demonstrate by some other method, acceptable to the Director, that the groundwater class TDS limits and protection levels* will be met by the receiving groundwater at a point as close as practical to the discharge point.

*If the applicant has or will apply for an alternate concentration limit (ACL), the ACL may apply instead of the class TDS limits and protection levels.

Submit a complete set of engineering plans and specifications relating to the construction, modification, and operation of the discharge point or system. Construction Permits for the following types of facilities will satisfy these requirements. They include: municipal waste lagoons; municipal sludge storage and on-site sludge disposal; land application of wastewater effluent; heap leach facilities; other process wastewater treatment equipment or systems.

Facilities such as storage piles, surface impoundments and landfills must submit engineering plans and specifications for the initial construction or any modification of the facility. This will include the design data and description of the leachate detection, collection and removal system design and construction. Provide provisions for run on and run-off control.

10. Compliance Monitoring Plan: (See Attachment 3, Compliance Monitoring Plan)

The applicant should demonstrate that the method of compliance monitoring selected meets the following requirements:

Groundwater Monitoring – that the monitoring wells, springs, drains, etc., meet all of the following criteria: is completed exclusively in the same uppermost aquifer that underlies the discharge point(s) and is intercepted by the up gradient background monitoring well; is located hydrologically down gradient of the discharge point(s); designed, constructed, and operated for optimal detection (this will require a hydrogeologic characterization of the area circumscribed by the background sampling point, discharge point and compliance monitoring points); is not located within the radius of influence of any beneficial use public or private water supply; sampling parameters, collection, preservation, and analysis should be the same as background sampling point; groundwater flow direction and gradient, background quality at the site, and the quality of the groundwater at the compliance monitoring point.

Source Monitoring – must provide early warning of a potential violation of groundwater protection levels, and/or class TDS limits and be as or more reliable, effective, and determinate than a viable groundwater monitoring network.

Vadose Zone Monitoring Requirements – Should be: used in conjunction with source monitoring; include sampling for all the parameters required for background groundwater quality monitoring; the application, design, construction, operation, and maintenance of the monitoring system should conform with the guidelines found in: Vadose Zone Monitoring for Hazardous Waste Sites; June 1983, KT-82-018(R).

Leak Detection Monitoring Requirements – Should not allow any leakage to escape undetected that may cause the receiving groundwater to exceed applicable groundwater protection levels during the active life and any required post-closure care period of the discharge point. This demonstration may be accomplished through the use of numeric or analytic, saturated or unsaturated, groundwater flow or contaminant transport simulations, using actual filed data or conservative assumptions. Provide plans for daily observation or continuous monitoring of the observation sump or other monitoring point and for the reporting of any fluid detected and chemical analysis thereof.

Specific Requirements for Other Methods – Demonstrate that: the method is as or more reliable, effective, and determinate than a viable groundwater monitoring well network at detecting any violation of groundwater protection levels or class TDS limits, that may be caused by the discharge or potential discharge; the method will provide early warning of a potential violation of groundwater protection levels or class TDS limits and meets or exceeds the requirements for vadose zone or leak detection monitoring.

Monitoring well construction and groundwater sampling should conform to A Guide to the Selection of Materials for Monitoring Well Construction. Sample collection and preservation, should conform to the EPA RCRA Technical Enforcement Guidance Document, OSWER-9950.1, September, 1986. Sample analysis must be performed by State-certified laboratories by methods outlined in UAC R317-6-6.3L. Analytical methods used should have minimum detection levels which meet or are less than both the groundwater quality standards and the anticipated protection levels.

11. Closure and Post Closure Plan: The purpose of this plan is to prevent groundwater contamination after cessation of the discharge or potential discharge and to monitor the discharge or potential discharge point after closure, as necessary. This plan has to include discussion on: liquids or products, soils and sludges; remediation process; the monitoring of the discharge or potential discharge point(s) after closure of the activity.

(See Appendix D of Groundwater Discharge Permit UGW350010)

12. Contingency and Corrective Action Plans: The purpose of this Contingency plan is to outline definitive actions to bring a discharge or potential discharge facility into compliance with the regulations or the permit, should a violation occur. This applies to both new and existing facilities. For existing facilities that may have caused any violations of the Groundwater Quality Standards or class TDS limits as a result of discharges prior to the issuance of the permit, a plan to correct or remedy any contaminated groundwater must be included.

Contingency Plan – This plan should address: cessation of discharge until the cause of the violation can be repaired or corrected; facility remediation to correct the discharge or violation.

Corrective Action Plan – for existing facilities that have already violated Groundwater Quality Standards, this plan should include: a characterization of contaminated groundwater; facility remediation proposed or ongoing including timetable for work completion; groundwater remediation.

(See Appendix C of Groundwater Discharge Permit UGW350010)

Certification

I certify under penalty of law that this document and all attachments were prepared under my direction or supervision in accordance with a system designed to assure that qualified personnel properly gather and evaluate the information submitted. Based on my inquiry of the person or persons who manage the system or those persons directly responsible for gathering the information, the information submitted is, to the best of my knowledge and belief, true, accurate, and complete. I am aware that there are significant penalties for submitting false information, including the possibility of fine and imprisonment for knowing violations.

Chris Kaiser, Manager - Environment
NAME & OFFICIAL TITLE (type or print)

(801) 569-2128
PHONE NO. (area code & no.)

SIGNATURE

11-19-14
DATE SIGNED

Attachment 1: Supplemental Hydrogeologic Report

South Waste Rock Reclamation

Groundwater Discharge Permit UGW350010 Modification

Kennecott Utah Copper LLC

November 2014



Kennecott Water Quality Group

THIS PAGE INTENTIONALLY LEFT BLANK

Contents

Section	Page
1.0 Introduction	1-1
1.1 Background	1-1
1.2 Purpose and Scope	1-2
2.0 Location, Setting, and Local Land Use	2-1
3.0 Geology	3-1
3.1 Regional and Local Structural Geology	3-1
3.1.1 Regional Structural Geology	3-1
3.1.2 Local Structural Geology	3-1
3.2 Regional and Local Stratigraphy	3-2
3.2.1 Regional Stratigraphy.....	3-2
3.2.2 Local Stratigraphy	3-3
3.2.3 Plio-Pleistocene Alluvial Fan Deposits and Modern Alluvium and Human-Made Fill	3-3
3.2.4 Tertiary Volcanic Bedrock	3-3
3.2.5 Paleozoic Bedrock.....	3-4
3.3 Drainage-Specific Geology	3-5
3.4 Local Topography and Soils.....	3-5
4.0 Hydrology and Hydrogeology.....	3-1
4.1 Surface Water Hydrology	4-1
4.2 Hydrogeology.....	4-2
4.3 Potential Discharge from SWWR	4-9
4.3.1 Total WRCW Seepage to Bedrock Estimate.....	4-10
4.3.2 Estimate of Potential Discharge to Bedrock.....	4-15
5.0 Groundwater Quality.....	5-1
5.1 Recent Compliance Monitoring Results.....	5-1
5.2 Baseline Water Quality of the Principal Aquifer	5-8
5.3 Applicable Groundwater Class.....	5-8
6.0 References.....	6-1

TABLES

- 1-1 Purpose of Information Contained in Attachment 1
- 2-1 Features within One Mile of South Waste Rock Reclamation
- 3-1 General Stratigraphic Column for SWRR Region
- 3-2 Summary of Drainage Specific Geology
- 4-1 Generalized Hydrostratigraphic Column
- 4-2 Details of Wells in the Vicinity of the South Waste Rock of the Eastside Collection System
- 4-3 Summary of Hydraulic Conductivity and Flow Velocity Estimates
- 4-4 Mixing Model Results for the Rate of Seepage to Bedrock
- 5-1 Compliance Well Water Quality
- 5-2 Water Quality Standards for Compliance Monitoring Wells
- 5-3a Compliance Monitoring Data Analysis Summary
- 5-3b Compliance Monitoring pH Analysis Summary
- 5-4 Baseline Water Quality of Principal Aquifer

FIGURES

- 1-1 Bingham Canyon Mine Site Overview
- 1-2 South Waste Rock Reclamation and Planned Collection Systems
- 2-1 Local Features
- 4-1 Groundwater Potentiometric Surface
- 4-2 Undisturbed Acreage
- 4-3 Sulfate Concentration with Saturated Thickness
- 4-4 Discretization for Spatial Weighting
- 5-1 Annual Average Sulfate and Total Dissolved Solids in Compliance Wells

Illustrations

- 4-1 South Waste Rock Conceptual Water Balance
- 4-2 Method of Estimating Waste Rock Contact Water Flow
- 4-3 Method of Estimating Waste Rock Discharge to Regional Bedrock

Drawings/Geological Cross Sections

- No. 1 Site Plan
- No. 2 Regional Surface Geology
- No. 3 Yosemite Drainage Area Site Plan
- No. 4 Yosemite Drainage Area Geologic Cross Sections
- No. 5 Butterfield 1 Drainage Area Site Plan
- No. 6 Butterfield 1 Drainage Area Geologic Cross Sections
- No. 7 Olsen Drainage Area Site Plan
- No. 8 Olsen Drainage Area Geologic Cross Sections

Appendices

- A Time Series Plots for Monitoring Wells in the Vicinity of the SWRR
- B USDA Natural Resources Conservation Service Custom Soil Report
- C Synthetic Liner Evaluation Technical Memorandum

Acronyms and Abbreviations

°	degree(s)
ACC	Advanced Copper Cementation
amsl	above mean sea level
BAT	Best Available Technology
BCM	Bingham Canyon Mine
bgs	below ground surface
DWQ	Division of Water Quality
ECS	Eastside Collection System
EPA	United States Environmental Protection Agency
EWRE	East Waste Rock Extension
ft ³ /min	cubic feet per minute
GCMP	Groundwater Characterization and Monitoring Plan
gpm	gallon(s) per minute
KTN	Kennecott True North
KUC	Kennecott Utah Copper, LLC
mg/L	milligram per liter
NOI	Notice of Intent
NR	no recent measurement
NRCS	National Resources Conservation Service
PVC	polyvinyl chloride
SO ₄	sulfate
SWRR	South Waste Rock Reclamation
TDS	total dissolved solids
TNW	traditionally navigable waterway
UAC	Utah Administrative Code
UDEQ	Utah Department of Environmental Quality
DWQ	Division of Water Quality
USACE	United States Army Corps of Engineers
USGS	United States Geological Survey
WCS	water collection system
WRCW	waste rock contact water

THIS PAGE INTENTIONALLY LEFT BLANK

1.0 Introduction

1.1 Background

Kennecott Utah Copper LLC (KUC) owns and operates the Bingham Canyon Mine (BCM), which produces copper and other metals from ore extracted from the mine (see Figure 1-1). Open pit operations have been conducted at this site for over 100 years. The waste rock associated with these mining operations has been placed adjacent to the open pit on the slopes of the Oquirrh Mountains. The waste rock disposal areas currently consist of over 5 billion tons of waste rock containing low-grade sulfide mineralization and trace metals from igneous intrusions of limestone and quartzite host rock.

KUC plans to extend operations through year 2030 by expanding the BCM in a project designated as Cornerstone. The Cornerstone mine expansion will significantly increase the amount of ore and waste rock, creating the need for additional waste rock capacity. The plan to place additional waste rock east of the existing dumps is identified as the East Waste Rock Extension (EWRE), which was permitted in 2013. KUC is also conducting reclamation through a project called identified as the South Waste Rock Reclamation (SWRR) where waste rock will be placed adjacent to South Dumps (see Figure 1-2), for which KUC is seeking a groundwater discharge permit modification.

Under the right conditions, water percolating through waste rock may dissolve sulfur-bearing minerals resulting in low pH pore water which, in turn, dissolves metals. The acidic, metal-bearing water that emerges from the toe of the waste rock is called acid rock drainage. The water that emerges from the toe of Bingham Canyon Mine's waste rock dumps varies in pH and dissolved metals concentrations. Water contacting waste rock, regardless of pH or dissolved metals concentrations, will be referred to as waste rock contact water (WRCW).

From the late 1920s through 1999, water was actively applied to the top of the waste rock dumps for the purpose of leaching copper. The applied water was collected at the base of the waste rock and processed for copper. The leachate collection was upgraded in 1965 and another major upgrade was completed in the early 1990s. This latest major upgrade, termed the Water Collection System (WCS), included planning for installation of cut-off walls built into bedrock of the natural drainages down gradient of the waste rock dumps to collect WRCW flowing on the surface and through alluvium. This system is also known as the Eastside Collection System (ECS). Maintenance and upgrades to the WCS have been ongoing since its installation.

Active leaching, which was in excess of 20,000 gpm, ceased in 2000. Flow records from the WCS indicate that the effects of water actively applied during leaching on cumulative discharge essentially ceased in approximately 2002 to 2003. Since that time, natural precipitation has been the only source of WRCW emerging from the waste rock dumps which is currently less than 1000 gpm.

KUC currently manages WRCW from the existing waste rock dumps including the SWRR area under Groundwater Discharge Permit No. UGW350010 (Permit), issued by the Utah Department of Environmental Quality (UDEQ), Division of Water Quality (DWQ) in 1999 and renewed approximately every 5 years thereafter. The most-recent renewal was issued March 15, 2010 (*Groundwater Discharge Permit No. UGW350010 for the Bingham Canyon Mine and Water Collection System, 2010*).

The western boundary of the principal aquifer is located within southwest Salt Lake Basin, close to the waste rock disposal areas to the south and east of the BCM. In conformance with the Permit, KUC built the WCS (see Figure 1-2) to capture and redirect WRCW and storm water. In addition, a monitoring well network was installed down gradient of the collection system. The existing WCS employs cut-off walls

and associated French drains to capture WRCW migrating along surface and alluvial channels. The walls are built into low permeable bedrock. The recovered WRCW is conveyed via gravity in piping to the Advanced Copper Cementation (ACC) Plant (also known as the Precipitation Plant) for the recovery of copper. A compliance groundwater monitoring well network is located down gradient of the WCS. More detail regarding the collection system and the compliance monitoring well network can be found in Attachments 2 and 3 of this application.

The monitoring network consists of compliance monitoring wells located along the down gradient perimeter of the BCM waste rock dumps. Through construction, operation, and monitoring of the existing WCS, KUC has effectively mitigated the release of WRCW from the property.

The proposed SWRR will require relocation of some WCS facilities including expanding the reclaimed waste rock footprint by 192 acres and relocating three cut-off walls/constructing four new cut-off walls. KUC will also incorporate engineering advances to the collection system making it as good as, or better than, the existing system. The proposed modifications are detailed in Attachment 2 and include the following:

- Relocation of three new cut-off walls along the relaxed toe of the SWRR
- Installation of new pipelines to replace existing lines down gradient of the cut-off walls to convey the WRCW
- Installation of an engineered store-and-release reclamation cover over the outer slope of the 6390 elevation bench of the waste rock to further minimize infiltration of meteoric water

The new design meets the standard of Best Available Technology (BAT) as described in Attachment 2, Groundwater Discharge Control Plan. The advances listed above will enhance the performance of the WCS, resulting in continued, long-term protection of groundwater resources and compliance with Permit requirements.

1.2 Purpose and Scope

The information in this attachment supports the following sections of the Permit modification application: Part B.3 and B.4 (Discharge Volumes and Potential Discharge Volumes) and Part C.8 (Hydrogeological Report). Table 1-1 summarizes the key information contained in this attachment and its purpose in support of the Permit modification application.

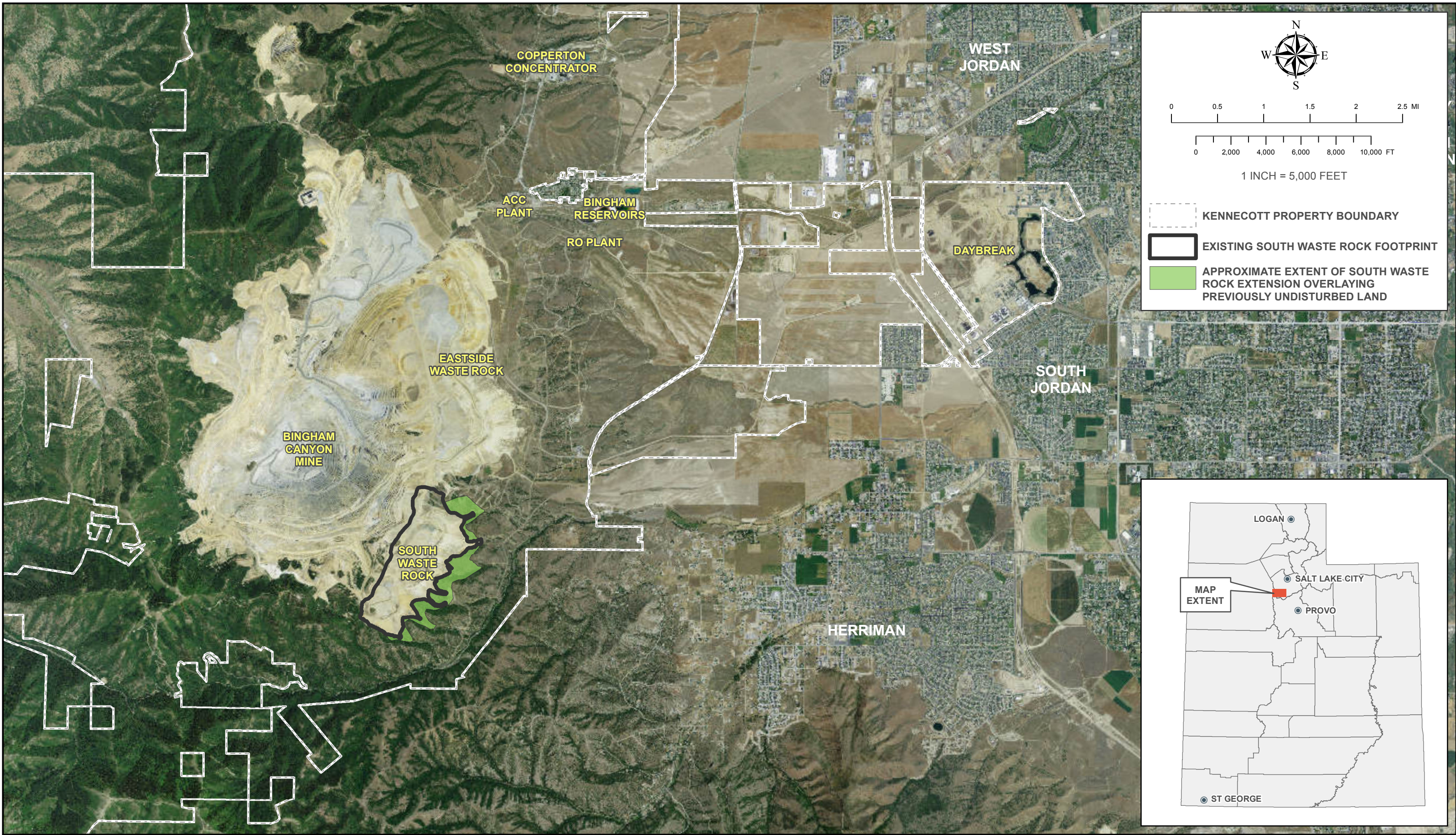

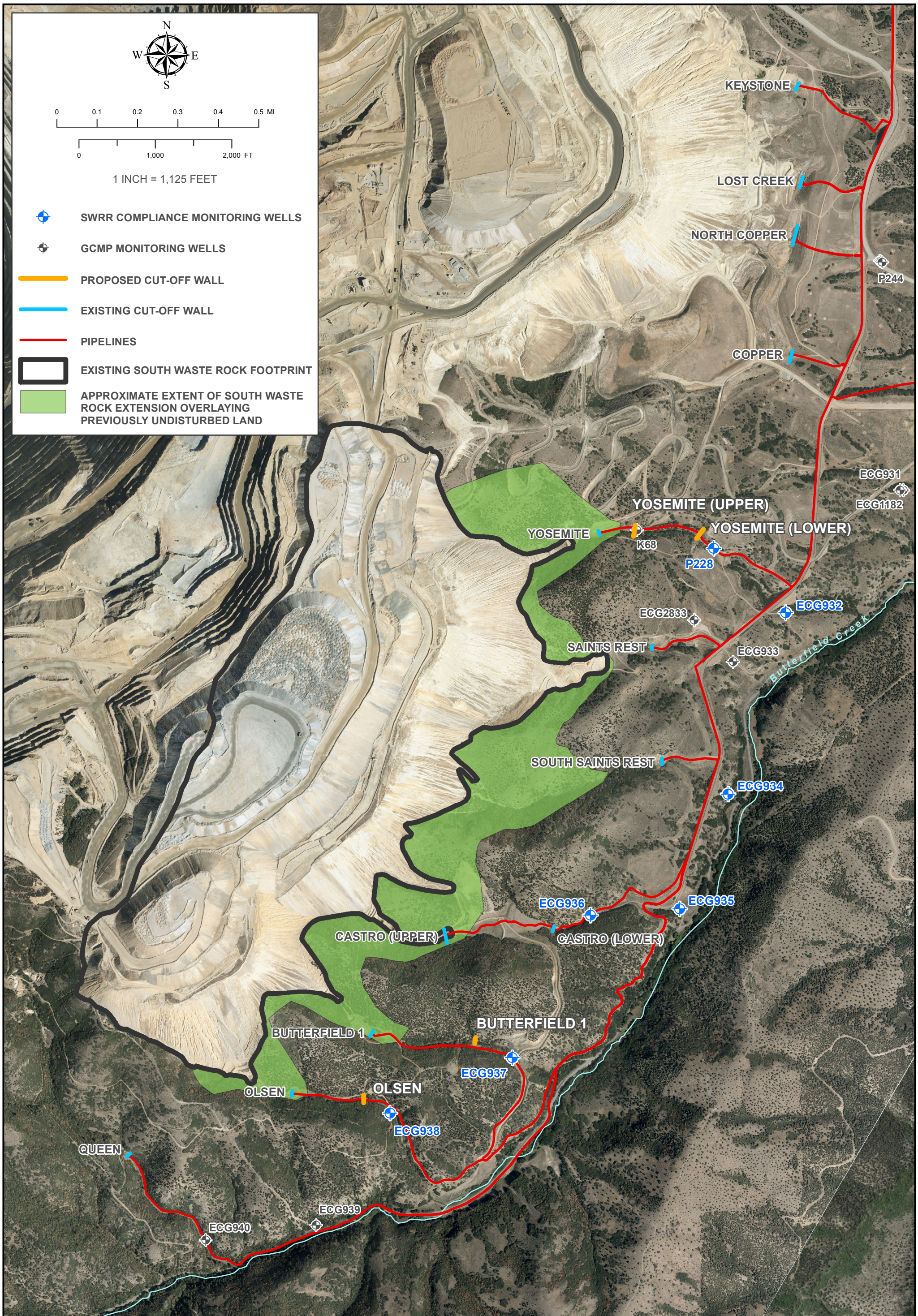

TABLE 1-1

Purpose of Information Contained in Attachment 1

Information	Purpose
Local and regional geological description, including structure, stratigraphy, and topography	Describe the setting in which groundwater resources exist Support discussion of potential WRCW migration, and mitigation of potential migration
Topography and soil description	Supports assessment of gravity drainage and design of the cut-off walls in Attachment 2 Brief description of soil included to validate that site soils are adequate for reclamation
Local and regional hydrology, including surface water hydrology and groundwater hydrogeology	Identify groundwater resources to be protected Support discussion of potential WRCW migration and mitigation of such potential migration
Information on the occurrence and magnitude of WRCW and its potential discharge to the ground	Supports estimation of discharge volumes required in Parts B.3 and B.4 of the Permit application modification
Drainages-specific geological information for drainages comprising the WCS	Supports cut-off wall design (see Attachment 2)
Summary of groundwater monitoring data	Supports the effectiveness of the existing WCS in mitigating WRCW impacts and the conclusion that the proposed, enhanced system will likewise be protective

NOTE:

The information in this Attachment satisfies the requirements of Part B.3 and B.4 (Discharge Volumes and Potential Discharge Volumes) and Part C.8 (Hydrogeological Report) of the Permit application.



THIS PAGE INTENTIONALLY LEFT BLANK

2.0 Location, Setting, and Local Land Use

The BCM is located in the Oquirrh Mountains approximately 19 miles southwest of Salt Lake City, Utah. Waste rock from the BCM is placed on the slopes of the Oquirrh Mountains, adjacent to the mine. Approximately 10 miles to the east of the Oquirrh Mountains is the Jordan River, within the southwestern Jordan Valley. This valley is an alluvium-filled basin containing a groundwater resource used as a water supply by some of the cities and residents within the valley. Figure 1-1 presents a site overview of the BCM and surrounding cities.

Most of the southwestern Jordan Valley is used for farming, industry, or suburban residential property. Agricultural development in the valley began in the early 1850s and has continued to the present. Irrigated land and dry farming have been declining in the area, giving way to increased residential use (see Figure 2-1). Currently, there is a small area of agricultural land use within the KUC property boundaries which include dryland wheat farming and beekeeping for honey production. Agricultural activities do not employ irrigation.

The Bureau of Land Management operates the Wild Horse and Burro Center southeast of the Yosemite drainage (see Figure 2-1). However, this facility is phasing out of operation.

Part A.9 of the Permit application requires identification and descriptions of wells, springs, water bodies, drinking water source protection zones, and human-made structures within a 1-mile radius of the point(s) of discharge site. This information is summarized in Table 2-1.



THIS PAGE INTENTIONALLY LEFT BLANK

TABLE 2-1
Features within One Mile of South Waste Rock Reclamation

Entity	Identifier	Type	NAD 83		Note	SWRR Facilities Within 1 Mile
			Latitude (decimal degrees)	Longitude (decimal degrees)		
Drinking Water Source Protection Zones						
Dansie Water Company, System # 18009, Zone-4	18009-001	Dansie Well	40.513604°	-112.090697°	1	Yosemite, Butterfield 1, Olsen
Herriman City Municipal Water Department, System # 18157, Zone-4	18157-006	HP Well No.1	40.512830°	-112.082874°	1	Yosemite, Butterfield 1, Olsen
Wells and Surface Water						
Underground Water Well The Last Holdout LLC	59-4118	Well	40.513370°	-112.089309°	--	Yosemite, Butterfield 1, Olsen
Underground Water Well Kennecott Utah Copper LLC	59-93	Well	40.511881°	-112.097720°	--	Yosemite, Butterfield 1, Olsen
Underground Water Spring Kennecott Utah Copper LLC	59-3275	Spring	40.509406°	-112.111801°	--	Yosemite, Butterfield 1, Olsen
Underground Water Tunnel Kennecott Utah Copper LLC	59-2465	Butterfield Tunnel	40.489023°	-112.122912°		Butterfield 1, Olsen
Underground Water Spring Kennecott Utah Copper LLC	59-1819	Spring	40.509406°	-112.111801°	--	Yosemite, Butterfield 1, Olsen
Surface Water Herriman Irrigation Company	59-4352	Butterfield Creek	--	--	--	Yosemite, Butterfield 1, Olsen
Surface Water Herriman Irrigation Company	59-4354	Butterfield Creek	--	--	--	Yosemite, Butterfield 1, Olsen
Structures						
Butterfield Tunnel	--	Structures	40.489023°	-112.122912°	--	Butterfield 1, Olsen
Streams						
Butterfield Creek	--	Stream	--	--	--	Yosemite, Butterfield 1, Olsen

NOTE:

1. Coordinates are for the westernmost portion of the Drinking Water Source Protection Zone.
2. * Butterfield Tunnel Portal labeled with water right 59-2465

THIS PAGE INTENTIONALLY LEFT BLANK

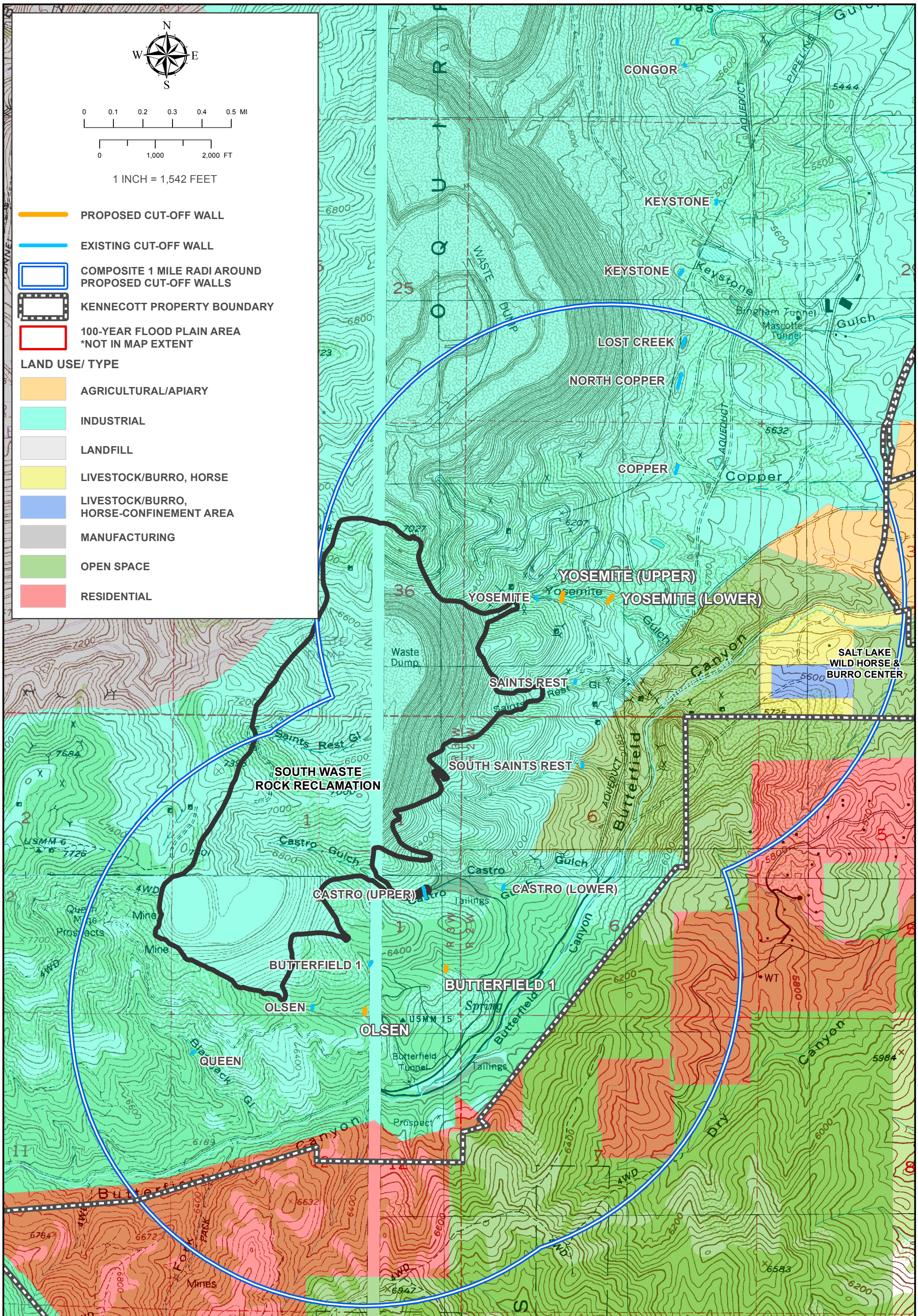

3.0 Geology

This section summarizes the structural geology and stratigraphy in the region and immediate vicinity of the SWRR and describes the surrounding topography, including applicable flood controls. Drainage-specific geological discussions are presented in Section 3.3.

3.1 Regional and Local Structural Geology

The BCM is located in the Oquirrh Mountains in the southwest corner of the Jordan River Valley along the eastern margin of the Basin and Range physiographic province. Surface geology for the SWRR area is shown in Drawing 2, and a site plan is shown in Drawing 1, at the end of this report.

3.1.1 Regional Structural Geology

The Oquirrh Mountains consist of a thick section of complexly folded and faulted upper Paleozoic sedimentary rocks (exhibiting different degrees of metamorphism), Tertiary intrusive and extrusive rocks, and late Tertiary sedimentary rocks (Presnell, 1992). Volcanic rocks contain three well-developed, steeply dipping joint sets, which trend northeast (dominant), northwest, and north-northwest. No significant surface faults are present along the eastern edge of the Oquirrh Mountains, although volcanic flows and dike intrusions appear to be controlled by preexisting (probably Early Tertiary) northeast-trending fractures of regional extent in Paleozoic basement (Smith, 1975).

Although no Late Tertiary reactivation of these structures is apparent, Bouguer gravity data and field observations suggest the presence of regional east-dipping normal faults along the base of the Oquirrh Mountains (Slentz, 1955a, b; Smith, 1961; Zoback, 1983). In Late Tertiary time, Basin and Range faulting produced uplift and erosion of the Oquirrh Mountains; much of the eroded material was deposited in the Jordan Valley, yielding unconsolidated to semiconsolidated basin-fill deposits of clay, silt, sand, gravel, and boulders.

In Late Pleistocene time, inundation of the Jordan Valley by Prehistoric Lake Bonneville produced lacustrine and shoreline deposits in the central valley below 5,200 feet above mean sea level (amsl). The contact between bedrock and alluvial deposits from the eastern edge of the Oquirrh Mountains to the Jordan River is poorly delineated by wells and only approximated by geophysical data.

3.1.2 Local Structural Geology

The SWRR is located at the western edge of a late Tertiary structural graben, which has been down-dropped along range-marginal faults at the edge of the Oquirrh Mountains. For the northern portion of the SWRR area, angular unconformities exist between the lithologic units in the area. The bedded volcanic units dip eastward into the Jordan Valley at moderate angles (~25 degrees [°]), as does the contact between Paleozoic basement and the volcanics. For the southern portion of the SWRR area, the volcanic bedrock is inter-bedded or subparallel to the Paleozoic bedrock bedding, striking generally northeast-southwest and dipping northwest. In the foothills of the Oquirrh Mountains, Plio-Pleistocene fan deposits dip 2° to 4° east to southeast; the dip shallows to less than 1° eastward in the main part of the southwestern Jordan Valley. Borehole logging data suggest that the fan deposit-volcanic contact dips 15° east near the eastern edge of the Oquirrh Mountains (Stewart, 1978).

There may be a range marginal fault at the eastern edge of the Oquirrh Mountains (Slentz 1955a, b; Crittenden 1964), though no reactivation of this structure is apparent. Numerous small fractures have been found in the volcanic bedrock east of the eastside waste rock dumps (CH2M HILL 2012b).

3.2 Regional and Local Stratigraphy

3.2.1 Regional Stratigraphy

The general stratigraphic sequence of the region is summarized in Table 3-1. The last column in Table 3-1 correlates the regional description with the mapped occurrences of these strata as shown on Drawing 2, included at the end of this report.

TABLE 3-1
General Stratigraphic Column for SWRR Region

Time Period	Symbols	Description	SWRR Geologic Map
Holocene	Qal	Recent strewn alluvium, colluvium, alluvial fans, and mudflows	
	Qfp	Recent abandoned flood plains and stream channels consisting of silt, sand, and gravel	
Pleistocene	Qplb	Provo Formation and younger lake bottom sediments; mainly clays, silts, and sands with local offshore sand bars	Quaternary & Tertiary Alluvial/Alluvial Fan Deposits
	Qp	Provo Formation and younger shore facies; chiefly sand and gravel in beach deposits, bars, spits, and deltas	
	Qb	Bonneville Formation; mainly shore facies of sand and gravel; includes beach deposits, bars, spits, and deltas	
Pliocene – Pleistocene	TQf	Fanglomerate consisting of unconsolidated and poorly sorted boulders, gravel, sand, and clay; the principal aquifer of the southwestern Jordan Valley	
Lower Oligocene – Upper Miocene	Tj	Salt Lake Formation, Jordan Narrows Unit; marlstone, limestone, sandstone, and tuff; may vary depending on locality	Not Exposed In Study Area
Upper Eocene and Oligocene	Tv	Volcanic rocks consisting of flows, breccias, lahars, tuffs, welded tuffs, stream-deposited pyroclastics, sills, and dikes; volcanics are chiefly latites or latite porphyries (+ hornblende)	Oligocene Volcanic Agglomerate and Latite Breccia Oligocene Latite & Andesite Flows
	Ti	Bingham Stock; intrusive, consisting mainly of quartz monzonite with quartz monzonite porphyry	Oligocene Intrusive Rocks-Mainly Silicic Dikes and Sills
Pennsylvanian – Lower Permian	P – IP	Undifferentiated Pennsylvanian through Lower Permian basin facies sedimentary rocks consisting of quartzites and limestones	Middle Pennsylvanian Butterfield Peaks Formation, Mainly Quartzite and Sandstone with Interbedded Limestone

NOTE:

Map symbols refer to geologic map in KUC (1992) Source: Davis (1983a, b); KUC (1992)

3.2.2 Local Stratigraphy

Drawing 2 presents a surface geological map for the SWRR area based on mapping by Kennecott staff and Swensen (KUC, 1991), while Drawings 4, 6 and 8 present geologic cross sections, included at the end of this report. The geologic cross sections were generated for drainages where a relocated cut-off wall will be placed as part of the SWRR and include:

- Yosemite drainage
- Butterfield I drainage
- Olsen drainage

The general stratigraphic sequence near the SWRR is unconsolidated colluvium and alluvium comprised of clayey quartzitic and volcanic gravels overlying more-competent bedrock consisting of andesite, latite porphyry, agglomerate and limestone and quartzite. The alluvial-volcanic or paleozoic contact commonly contains caliche and displays a weathering profile in the underlying bedrock. The bedrock contains undifferentiated sills and dikes (KUC, 1991). Angular unconformities and subparallel bedding exist between the Oligocene volcanics and the Paleozoic units.

Depth to bedrock encountered during the field studies ranged from 0 to 75 feet below ground surface (bgs), approximately 100 to 600 feet east or southeast of the anticipated relocated cut-off walls of the waste rock placement area. For the remainder of this Attachment, as well as Attachments 2 and 3 of this submittal, the term bedrock is operationally defined as a native semi-impermeable surface, which may include consolidated rock or the weathered byproduct of the consolidated rock that has sufficient competency to support a concrete water-capture structure.

3.2.3 Plio-Pleistocene Alluvial Fan Deposits and Modern Alluvium and Human-Made Fill

Surficial stratigraphy near the SWRR consists of Plio-Pleistocene alluvial fan deposits, which extend from the toe of the waste rock disposal area into the southwestern Jordan Valley. These alluvial fan deposits consist of gravels, sands, silts, and clays. The alluvial deposits, which in the vicinity of the SWRR are approximately 0 to 35 feet thick, rest on Tertiary volcanic bedrock or Paleozoic bedrock. The alluvial deposits thicken eastward to form the principal aquifer of the southwestern Jordan Valley.

Holocene alluvium—consisting of cobbles, pebbles, coarse to fine sand, silt, and clay deposits—lies mainly along the valleys of the drainages emerging from the toe of the waste rock disposal area. Alluvium is sparse at the toe of the waste rock disposal areas. Coarse colluvial material consisting of boulders mixed with silt occurs on the steeper slopes at the site, often extending beneath the waste rock disposal areas. The thickness of these Holocene deposits generally ranges from 1 to 25 feet.

The human-made fill materials contain locally acquired and re-worked quaternary and tertiary alluvial/colluvial sediment consisting of silty gravels to gravelly silts and silty sand mixtures that can include organic material. The organic materials observed in test pits and borings were consistent with local vegetation.

3.2.4 Tertiary Volcanic Bedrock

Volcanic bedrock underlie the eastern edge of the waste rock disposal area and also crops out along the northern portion of the SWRR area. The Tertiary volcanics are described regionally as a thick (<2,000 feet) section of lithologically complex Oligocene silicic volcanic and shallow intrusive rocks lying with angular unconformity on Paleozoic bedrock. The volcanics consist of laharic breccias, latitic flows, flow breccias, and intrusive rocks, including latite dikes and small monzonitic stocks (Davis, 1983a,b). This sequence acts as “basement” to the Plio-Pleistocene alluvial fan deposits for the northern portion of the

SWRR area, which are host to the principal aquifer. For the southern portion of the SWRR area, the silicic volcanic units are sub-parallel to the Paleozoic bedrock.

Volcanic Agglomerate. Volcanic agglomerate bedrock was encountered at the Yosemite drainage and was observed to range from competent bedrock to well-weathered gravelly clay altered sequences. This material ranged from clayey volcanic gravel to highly altered gravelly clay, depending on the degree of weathering. Drilling in the agglomerate occasionally produced a solid rock core through a 6- to 12-inch competent horizon, revealing heavily weathered material below. Within these horizons, there was often increased moisture content and oxidation staining indicating geochemical weathering.

Andesite. Volcanic andesite flow deposits were logged in several of the test pits and outlier borings adjacent and north of the SWRR area in the Copper 4 drainage. This bedrock contact was observed in varying degrees of weathering ranging from low competency, highly altered clay material to highly competent solid rock surfaces. Many of the overburden-andesite contacts were weathered to clay, often with visible standing water located along the weathered bedrock contact in several of the test pits. The relatively high percentage of potassium and other feldspars in the andesite are more susceptible to weathering than quartz and are often altered into low permeability clays. The upper 1 or 2 feet of weathered material often exhibited abundant oxidation staining. There were no observations that suggest the andesite supported fractures could contribute to extensive groundwater flow. Instead, the andesite seemed to behave as a low-permeability barrier when exposed to moisture and allowed to weather.

Latite Porphyry. Latite porphyry was observed in several test pits and bedrock crops north of the SWRR area and may be present for the project area. This bedrock type was observed to contain numerous fractures and appears to have some resistance to weathering into clay (due to higher percentage of quartz) when compared with the local andesite.

3.2.5 Paleozoic Bedrock

Beneath the Tertiary volcanic bedrock, subcropping below the southern and westerly parts of the waste rock dumps are quartzites and limestones of Paleozoic age. Paleozoic bedrock is exposed in the SWRR is complexly deformed, altered, and intruded by mid-Tertiary silicic igneous rocks (Swenson, 1975; Presnell, 1992). The thickness of Paleozoic bedrock is difficult to estimate because of complex structure (Presnell, 1992); but it probably ranges from 10,000 feet to more than 30,000 feet (Crittenden, 1977; Lund et al., 1990).

3.3 Drainage-Specific Geology

Detailed information on the stratigraphy near the locations of the proposed, re-located cut-off walls was developed during the 2014 field investigations (CH2M HILL, 2014). Information relevant to the design and performance of the proposed, relocated cut-off walls is summarized below in Table 3-2.

TABLE 3-2
Summary of Drainage Specific Geology

Drainage Name	Alluvium Description	Depth to Bedrock (feet bgs)	Bedrock Description	Cross Section Drawing Numbers
Yosemite	Clayey quartzitic gravel with sand grading to inorganic clay	15-44	Volcanic agglomerate	3, 4
Butterfield 1	Quartzitic gravel with sand, silt, and clay	3-6	Limestone	5, 6
Olsen	Silty quartzitic gravel	6-10	Quartzite/limestone	7, 8

3.4 Local Topography and Soils

The SWRR is located on the eastern foothills of the Oquirrh Mountains. The topography slopes to the east toward the southwestern Jordan Valley. Soils in the SWRR disposal area are derived from Quaternary alluvial, colluvial, and aeolian sediments (Miller 1980; KUC 1992). With the exception of areas affected by human activities, including outwash from mining areas, the area incorporates a complex series of soils ranging from silty or clayey to stony loams.

Figure 2-1 identifies the SWRR area on a United States Geological Survey (USGS) map, 7½ minute series and identifies KUC's legal site boundaries and indicates the 100-year flood plain areas. For information about the groundwater collection system and storm water control, see Attachment 2, *Groundwater Discharge Control Plan*.

Soils are typically deep to moderately deep on north facing slopes (greater than 6 to 5 feet) and well drained. The Natural Resources Conservation Service (NRCS) Custom Soil Resource Report (<http://websoilsurvey.nrcs.usda.gov/app/WebSoilSurvey.aspx>) for the SWRR is included as Appendix B. NRCS reports well-drained, loamy native soils with varying degrees of clay, silt, sand, gravel, and cobbles. The types and volumes of native soil present within the SWRR footprint are adequate for use as a vegetated store-and-release cover to be placed over top the waste rock. The vegetated store-and-release cover is summarized in Attachment 2.

THIS PAGE INTENTIONALLY LEFT BLANK

4.0 Hydrology and Hydrogeology

4.1 Surface Water Hydrology

The only naturally flowing perennial stream in the vicinity of the SWRR area is Butterfield Creek. This is a gaining stream in the Oquirrh Mountains, and an intermittent, losing stream in the basin fill of the Jordan Valley (Dames and Moore, 1988). The average flow of Butterfield Creek was about 3 cubic feet per second in 1990 (Salt Lake County, 1991). Typical water quality results for Butterfield Creek are summarized in the Groundwater Assessment Report of the Southwestern Jordan Valley (KUC, 1992).

The nearest major perennial waterway is the Jordan River located approximately 9.5 miles east of the SWRR. The cut-off wall collection system will deliver WRCW and storm water to the ESC for delivery to the ACC Plant or to wastewater disposal pump station. No mine-impacted water discharges to natural surface water bodies. The systems described in Attachment 2 will continue to prevent surface water and alluvial impacts by eliminating direct discharges to surface water; and by minimizing impacts to the regional alluvial aquifer.

In the spring of 2011, WP Natural Resource Consulting, Inc. (2011) was contracted to delineate potential wetlands and waters of the United States on KUC lands in the vicinity of the SWRR. The investigation area included a number of named and unnamed drainages along the eastern side of the waste rock dumps and areas on south-facing slopes in Butterfield Canyon. Isolated wetlands (i.e., no connectivity or nexus to a Traditional Navigable Waterway [TNW]) were identified. Additionally, a number of ephemeral draws with evidence of ordinary high water marks were identified; however, these features were all associated with nearby road storm water runoff. Other hydric features identified in the investigation area are associated with groundwater that has surfaced through the waste rock dumps at the eastern and southern sides of the SWRR vicinity. The results of the surveys reveal that there are no potential jurisdictional wetlands within the project area, and no waters of the United States as defined by the United States Environmental Protection Agency (EPA) and the United States Army Corps of Engineers (USACE).

4.2 Hydrogeology

Regional groundwater occurs in each of the main stratigraphic units described in Section 3.0, Geology. Table 4-1 is a summary of the regional hydrostratigraphic column whereas Table 4-2 provides details for wells in the vicinity of the South Waste Rock Collection System.

TABLE 4-1
Generalized Hydrostratigraphic Column

Description	Hydrostratigraphic Classification	Estimated Thickness (feet)	At the SWRR (feet bgs)	Associated with Well on Cross Sections*
Holocene alluvium and human-made fill, unconsolidated cobbles, pebbles, coarse to fine sand, silt and clay, mantles entire southwestern Jordan Valley	Matrix containing thin discontinuous zones of perched groundwater	1-25	At surface	P228
Plio-Pleistocene alluvial fan deposits, generally well-stratified, slightly consolidated sand and gravels, which are relatively rich in carbonate material; constitutes the principal aquifer	Aquifer	< 50	< 50	N/A
Tertiary volcanic rocks, mainly latites, breccias, latite flows	Aquifer (fracture flow)	<2,000	>50	ECG2833
Paleozoic bedrock, generally limestone, quartzite	Aquifer (fracture flow)	~10,000-30,000	> 300	ECG938

* See Geological Cross Sections Drawings 4, 6 and 8

TABLE 4-2
 Details of Wells in the Vicinity of the South Waste Rock Collection System

Site ID	Alias	NAD 83		Easting-KTN (feet)	North-KTN (feet)	Measuring Point Elevation (feet)	Ground Surface Elevation (feet)	Well Type	Casing Material	Screen Type	Screened Interval (feet bgs)	Total Well Depth (feet bgs)	Screened Lithology Type	Screened Lithology Description	Date of Groundwater Measurement	Depth to Water (feet)	Range of depth to Water (feet)
		Longitude	Latitude														
ECG924		-112.099333	40.519078	16,870	661	5,588.47	5,586.51	Non-SWRR Compliance Well	PVC	Slotted - Factory	67.1-106.7	107.2	Bedrock	Andesite	9/25/2014	31.84	3.56
ECG925		-112.097173	40.520949	17,470	1,343	5,555.00	5,553.26	Non-SWRR Compliance Well	PVC	Slotted - Factory	67.1-106.7	107.2	Bedrock	Andesite	9/25/2014	35.46	8.69
ECG926		-112.09635	40.524259	17,698	2,549	5,545.80	5,544.05	GCMP	PVC	Slotted - Factory	162.2-201.8	202.3	Bedrock	Latite	9/25/2014	38.00	9.03
ECG931		-112.101045	40.515322	16,395	-708	5,619.60	5,618.15	Non-SWRR Compliance Well	PVC	Slotted - Factory	105-144.6	145.1	Bedrock	Andesite	9/25/2014	50.61	13.28
ECG932		-112.106375	40.510886	14,914	-2,325	5,714.11	5,712.61	SWRR Compliance Well	PVC	Slotted - Factory	145-184.6	185.1	Bedrock	Andesite	9/25/2014	83.65	13.04
ECG933		-112.108849	40.509115	14,227	-2,975	5,693.48	5,692.13	GCMP	PVC	Slotted - Factory	142.2-181.8	182.3	Bedrock	Quartzite Breccia/Quartzite	9/25/2014	120.98	8.97
ECG934		-112.109028	40.504369	14,177	-4,704	5,696.04	5,694.39	SWRR Compliance Well	PVC	Slotted - Factory	187.2-226.8	227.3	Bedrock	Limestone	9/25/2014	118.57	12.82
ECG935		-112.111263	40.500235	13,555	-6,210	5,760.50	5,758.74	SWRR Compliance Well	PVC	Slotted - Factory	88.7-128.3	128.8	Bedrock	Andesite	9/25/2014	52.93	2.80
ECG936		-112.115456	40.499979	12,389	-6,303	5,887.58	5,886.14	SWRR Compliance Well	PVC	Slotted - Factory	82.2-121.8	122.3	Bedrock	Limestone/ Latite Porphyry	9/25/2014	47.32	9.54
ECG937		-112.119090	40.494483	11,378	-8,174	6,043.86	6,042.59	SWRR Compliance Well	PVC	Slotted - Factory	276.2-315.8	316.3	Bedrock	Limestone	9/25/2014	242.98	14.10
ECG938		-112.124032	40.492896	9,785	-8,909	6,198.23	6,196.93	SWRR Compliance Well	PVC	Slotted - Factory	242.2-281.8	282.3	Bedrock	Limestone/ Quartzite	9/25/2014	214.04	5.40
ECG939		-112.128261	40.488783	8,827	-10,382	6,070.53	6,068.89	GCMP	PVC	Slotted - Factory	112.0-151.6	152.1	Bedrock	Quartzite/ Limestone	9/25/2014	86.47	5.14
ECG940		-112.133446	40.488219	7,385	-10,587	6,198.10	6,196.00	GCMP	PVC	Slotted - Factory	197.8-237.4	237.9	Bedrock	Quartzite/ Andesite	9/25/2014	117.82	14.10
VWP228	P228	-112.109793	40.513177	13,963	-1,491	5,785.21	5,785.21	SWRR Compliance Well	Unidentified	Unidentified	Unknown-84?	84.0	Alluvium	Quartz gravel??	9/25/2014	25.43	7.98
VWP244A	P244A	-112.102063	40.523538	16,110.01	2,285.25	5,673.97	5,671.78	Non-SWRR Compliance Well	PVC	Slotted - Factory	36.58-46.58	47.6	Alluvium	Quartzite gravel	9/25/2014	44.88	3.48
VWP244B	P244B	-112.102014	40.523518	16,123.47	2,278.06	5,673.05	5,671.62	Non-SWRR Compliance Well	PVC	Slotted - Factory	62.54-72.54	72.5	Bedrock	Quartzite gravel/rhyolite	9/25/2014	49.23	3.70

TABLE 4-2
 Details of Wells in the Vicinity of the South Waste Rock Collection System

Site ID	Alias	NAD 83		Easting-KTN (feet)	North-KTN (feet)	Measuring Point Elevation (feet)	Ground Surface Elevation (feet)	Well Type	Casing Material	Screen Type	Screened Interval (feet bgs)	Total Well Depth (feet bgs)	Screened Lithology Type	Screened Lithology Description	Date of Groundwater Measurement	Depth to Water (feet)	Range of depth to Water (feet)
		Longitude	Latitude														
VWP244C	P244C	-112.101957	40.523486	16,139.44	2,266.32	5,673.07	5,671.31	Non-SWRR Compliance Well	PVC	Slotted - Factory	107.35-127.35	127.4	Bedrock	Agglomerate	9/25/2014	53.51	6.43
ECG1184		-112.095936	40.513043	17,816	-1,537	5,453.30	5,450.69	GCMP	PVC	Slotted - Factory	60-80	80.50	Alluvium	Quartzite gravel	9/25/2014	45.60	24.99
VWP214A	P214A	-112.091511	40.518879	19,044.87	586.56	5,459.58	5,457.31	GCMP	PVC	Unidentified	262-275	275.0	Alluvium??/ Bedrock??	Gravel??	9/20/2014	39.88	8.71
VWP270	P270	-112.090113	40.512803	19,438	-1,632	5,406.24	5,402.90	GCMP	PVC	Slotted - Factory	179-199	199.0	Bedrock	Agglomerate	9/20/2014	20.75	19.89
VWP271	P271	-112.091846	40.523442	18,957	2,244	5,483.41	5,480.60	GCMP	PVC	Slotted - Factory	65-85	85.0	Bedrock	Agglomerate	9/21/2014	44.57	4.10
VWW41A		-112.089760	40.513437	19,536.2	-1,401.04	NR	5,388.58	GCMP	Steel	Perforated	73-45	190.00	Unknown	Unknown	NR	NR	NR
ECG1182A		-112.100895	40.515292	16,436.81	-712.27	5,619.37	5,617.11	GCMP	PVC	Slotted - Factory	580-600	680.00	Bedrock	Latite autobreccia	9/25/2014	59.61	11.35
ECG1183A		-112.091700	40.518849	18,992.3	578.99	5,462.74	5,460.18	GCMP	PVC	Slotted - Factory	35-65	35.0	Alluvium/ Bedrock	Quartzite gravel/ andesite flow	9/20/2014	43.67	4.30
ECG2833A		-112.110170	40.510373	13,718.41	-2,429.03	5,787.76	5,785	GCMP	PVC	Slotted - Factory	157.4-167.4	167.9	Bedrock	Volcanics/ Andesite	10/26/2012	128.70	--

NOTES:

?? = Uncertainty, this is often due to a missing log. Geology filled in using neighboring well.

KTN = Kennebec True North

bgs = below ground surface

PVC = polyvinyl chloride

NR = no recent measurements (Period 1992 to September 2014).

The principal water-bearing aquifer near the BCM is the Southwestern Jordan Valley Aquifer. Near the SWRR, this aquifer originates in the Plio-Pleistocene alluvial fan and lacustrine sediment deposits. These deposits thicken toward the east and lie above the Tertiary volcanic bedrock and Paleozoic bedrock which form the Oquirrh Mountains. The alluvial sediments are composed of reworked volcanic materials along with quartzitic alluvial materials. Groundwater primarily enters the alluvial aquifer from the shallow volcanic and deeper Paleozoic bedrock.

The potentiometric surface roughly mirrors topography near the SWRR and the overall flow direction ranges from approximately southeast to east (see Figure 4-1). The gradient of the water table is steep in the western and southwest portion of the waste rock disposal area (averaging 0.2 foot per foot) as a result of the flow taking place in the relatively low-permeability bedrock making up the Oquirrh Mountains. Bedrock consists of volcanic silicic rocks above or sub-parallel with the Paleozoic sedimentary rock. The water table gradient is more gradual (approximately 0.05 foot per foot) farther east from the Oquirrh Mountains in the principal aquifer.

The depths to water measured around the SWRR for monitoring wells installed in alluvium ranged from 20.75 feet bgs at monitoring well VWP270, which is a little over 1/2 mile down gradient (east) of the current toe of the waste rock dump and along Butterfield Creek, to 242.98 feet bgs at ECG937 in bedrock, which is down gradient of the proposed relocated Butterfield 1 cut-off wall (see Table 4-2).

Water levels in most of the compliance wells show seasonal variations but no clear trends. Wells adjacent and north of the SWRR with the largest decline in water levels are located down gradient of the historic leach water application sites. Most of the decline that occurred between 2002 and 2004, following the cessation of active leaching of waste rock on the eastside dumps, eventually returned to pre-1998 water levels. However, water levels have tended to rapidly respond to above-average years of precipitation (i.e. following above-average precipitation observed in 2010-2011).

Hydraulic conductivity describes the ease in which water can move through pore spaces or fractures. Groundwater flow velocities can be estimated from knowledge of the hydraulic conductivity, hydraulic gradient, and the effective porosity at any location. In addition, velocities can be directly evaluated on the rapidity of movement of dissolved, conservative materials through the groundwater system. Table 4-3 summarizes estimates of hydraulic conductivity and groundwater flow velocity based on a number of site specific evaluations (Dames and Moore 1989; Adrian Brown Consultants, Inc. and Adrian Smith Consulting Inc. (ABC/ASCI) 1990; KUC 1992).

TABLE 4-3
Summary of Hydraulic Conductivity and Flow Velocity Estimates

Aquifer	Hydraulic Conductivity (centimeters/second)	Flow Velocity (feet/year)
	Min—Max (geometric mean)	[Range of Estimates]
Plio-Pleistocene alluvium	5×10^{-5} - 3×10^{-3} (3×10^{-3}) ^A	500
Tertiary volcanic bedrock	7×10^{-7} to 5×10^{-2} (5×10^{-5}) ^A	6 to 500
Paleozoic bedrock	5×10^{-6} to 5×10^{-4} (5×10^{-5}) ^A	100 to >1000

^A(KUC, 1994)

The mean hydraulic conductivity of the bedrock units is more than two orders of magnitude lower than the alluvium, which results in local perching of groundwater at the alluvium-bedrock contact. This is a key consideration in the WRCW collection system (see Attachment 2), which incorporates cut-off walls to capture groundwater at this contact.



THIS PAGE INTENTIONALLY LEFT BLANK

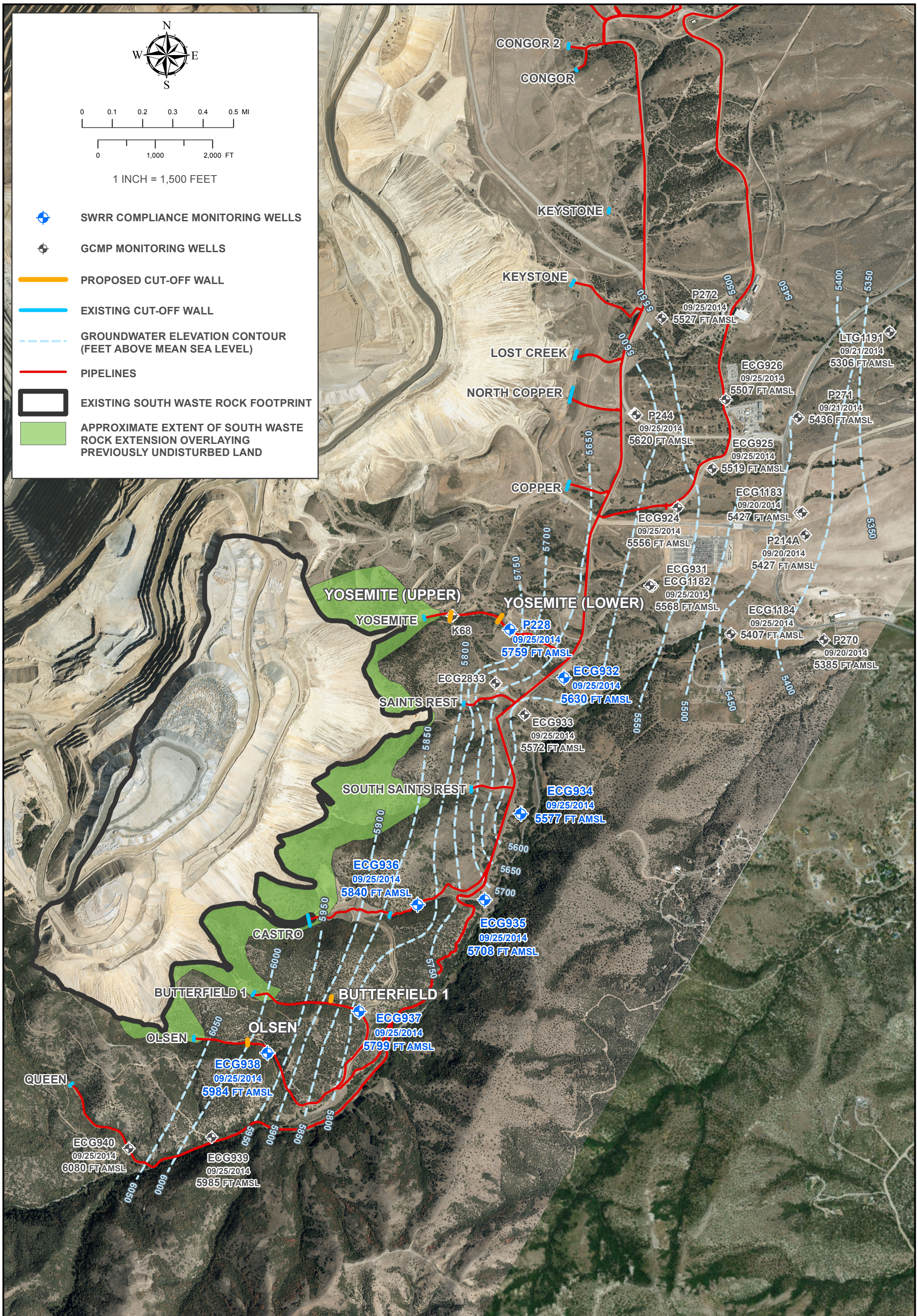

1 INCH = 1,500 FEET

- SWRR COMPLIANCE MONITORING WELLS
- GCMP MONITORING WELLS
- PROPOSED CUT-OFF WALL
- EXISTING CUT-OFF WALL
- GROUNDWATER ELEVATION CONTOUR (FEET ABOVE MEAN SEA LEVEL)
- PIPELINES
- EXISTING SOUTH WASTE ROCK FOOTPRINT
- APPROXIMATE EXTENT OF SOUTH WASTE ROCK EXTENSION OVERLAYING PREVIOUSLY UNDISTURBED LAND

4.3 Potential Discharge from SWRR

Part B of the Permit application requires defining the type of fluid to be discharged and the maximum potential volume that could be discharged to the ground. For this Permit modification application, the fluid potentially discharged to the ground is defined as WRCW emanating from the base of the proposed SWRR footprint. The majority of the WRCW will report to the collection system, while a minor portion of the WRCW will potentially infiltrate into the underlying bedrock. A brief summary of the SWRR water balance is provided below to introduce the approach taken to estimate potential discharge volume.

Illustration 4-1 shows a schematic representation of a water-balance conceptual model related to the SWRR. The sole inflow to the system is infiltration of rain and snowmelt at the surface of the waste rock dump. Annual precipitation at the BCM ranges from 16 to 30 inches dependent upon elevation. To allow comparison with other flow estimates presented below, the 16 to 30 inch/year linear precipitation estimate was converted to an annual average volumetric flow estimate of 159 gpm to 279 gpm over the 192 acre SWRR footprint overlying previously undisturbed ground.

Losses of water from the waste rock will occur via the following processes:

1. Evaporation, sublimation of snow and transpiration by plants will remove water from the top of the system. These processes will be enhanced through the use of an engineered store and release cover system which is explained in more detail in Attachment 2. Engineered covers for similar climates have demonstrated overall reductions in infiltration of precipitation by 85 percent of total precipitation (Warren, et al., 1995).
2. A percentage of precipitation will run-off the reclaimed waste rock slope. The storm water management features associated with the SWRR design will capture and direct rain and snowmelt off of the dump, further reducing the volume of water available for infiltration and deep percolation however there is insufficient information to quantify reduced infiltration by this process. The storm water system is explained in detail in Attachment 2.
3. Water-consuming chemical reactions within the waste rock will result in formation of minerals such as jarosite and gibbsite (Younger, 2002; Chou, et al., 2002; Swayze, et al., 2008). The prevalence of such minerals in the existing waste rock dumps suggests this process is widespread, however there is insufficient information to quantify water losses by this process.
4. Water that infiltrates deep into the waste rock will reach the contact between the waste rock and bedrock and will ultimately be collected in the toe drains and cut-off walls. Section 4.3.1 estimates the volume of water reaching bedrock.
5. A small fraction of the WRCW reaching this contact will seep into bedrock. Section 4.3.2 addresses methods for estimating the volume of this seepage, as required by Part B of the Permit application.

WRCW from current operations is captured in the existing WCS. WRCW from the SWRR and existing waste rock dump will be captured in an advanced collection system described in Attachment 2. Furthermore, implementation of the proposed storm water collection system and store-and-release cover will minimize infiltration.

ILLUSTRATION 4-1
SWRR Conceptual Water Balance

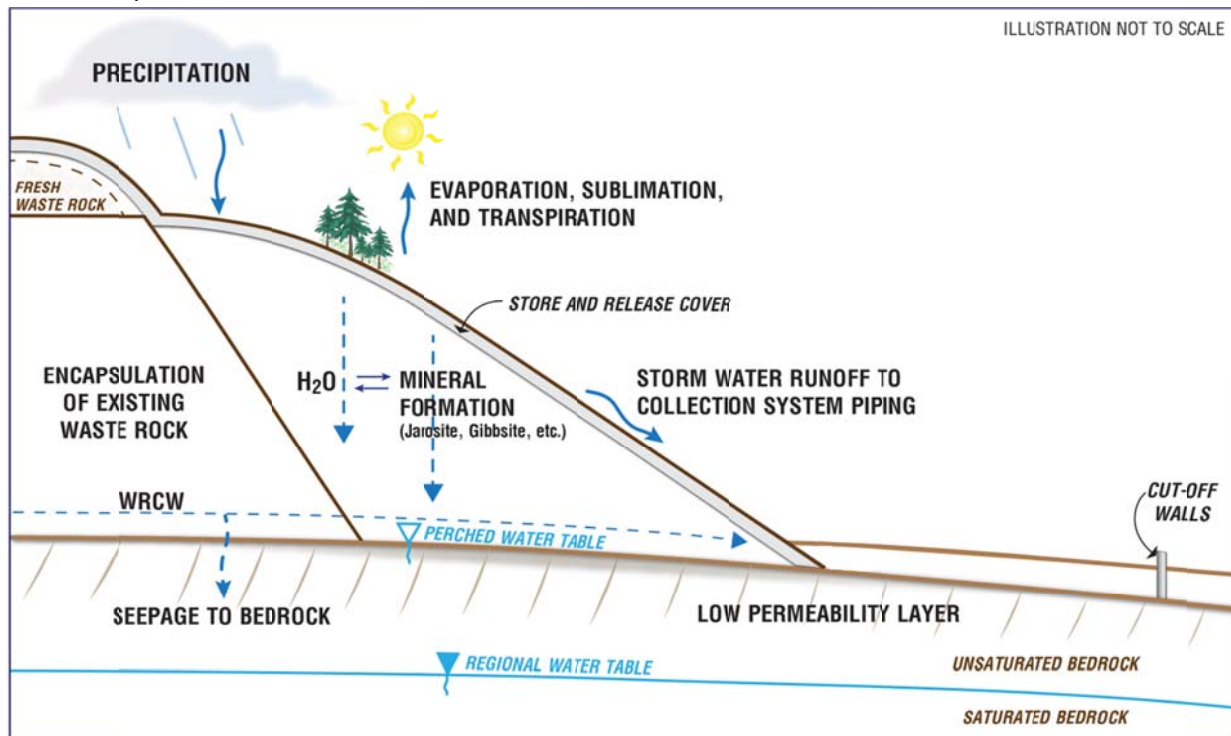

4.3.1 Total WRCW Seepage to Bedrock Estimate

This section assesses the potential volume of seepage into bedrock below the SWRR by using a mass-balance approach based partly on current groundwater chemistry data. The data used represent the impacts of existing waste rock dumps and past practices on the principal aquifer but are used in this section to extrapolate potential future seepage from the SWRR. This is a conservative approach because current groundwater geochemistry likely retains a substantial signature of mass loading from the existing waste rock dump that began in the 1960s and WRCW seepage into bedrock that occurred prior to construction of the WCS.

The maximum volume of WRCW to potentially emanate from the SWRR can be estimated based on current flows captured in the WCS and the assumption that the WRCW discharge rate is proportional to surface area of the waste rock dumps. The area of the proposed SWRR that will overlie currently undisturbed land is approximately 192 acres (see Figure 4-2). The existing waste rock dump footprint acreage west of the proposed SWRR is approximately 577 acres. Thus, the SWRR area represents approximately 33 percent of the existing waste rock dumps.

The average flow captured in the WCS since 1999 in drainages downslope from the proposed SWRR is approximately 65 gpm. The following drainages were included in this analysis: Yosemite, Saints Rest, South Saints Rest, Castro, Butterfield 1 and Olsen. Year 1999 was selected as the starting point through 2013 for flow records for this analysis because that is when the original groundwater discharge permit was issued. Using the 33 percent spatial weighting factor calculated above, total WRCW flow from the SWRR is estimated at 21 gpm \pm 7 gpm. For reasons noted previously, this should be considered a maximum estimate since planned reclamation and storm water controls are designed to greatly reduce

percolation of precipitation and proportionally reduce WRCW formation in both the SWRR and existing waste rock dumps.

Illustration 4-2 provides an overview of the methods and assumption employed in this estimation of WRCW flow from the SWRR.

ILLUSTRATION 4-2
Method of Estimating Waste Rock Contact Water Flow

Goal: Estimate the total volume of WRCW emanating from the base of the proposed SWRR. This estimate is for the total flow of WRCW, not the potential flow percolating into bedrock (see Illustration 4-3).

Method: The calculation assumed that the flow of WRCW is proportional to the surface areas of the waste rock dumps. Thus, if the SWRR increases the surface area of the waste rock dumps by 33 percent, the increase in total WRCW flow is assumed to be 33 percent of the current flow.

Step 1

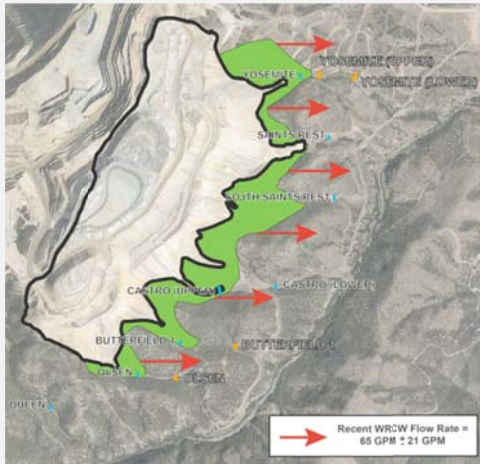

Estimate the total average WRCW flow from waste rock dumps west of the proposed SWRR (\pm one standard deviation). The estimate was based on flume data associated with the WCS for the Yosemite through Olsen drainages. Flume data from 1999 to present was selected to represent the time period in which natural precipitation was the dominant source of percolation in the waste rock and not influenced by other water management practices.

Step 2

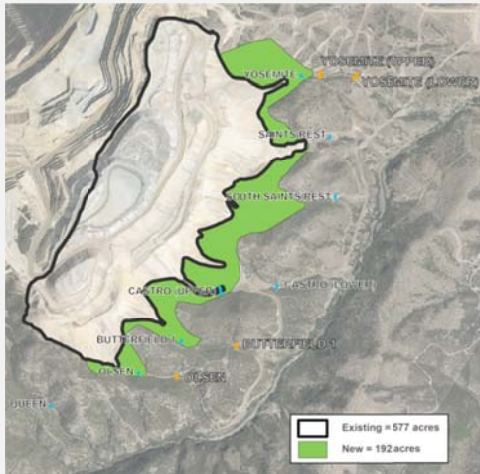

Estimate the acreage of existing waste rock dumps upstream of the proposed SWRR (577 acres).

Step 3

Estimate the acreage of the proposed SWRR (192 acres) that will cover currently undisturbed acreage. WRCW flow from existing slopes is accounted for in Step 1.

Step 4

$192 \text{ acres} \div 577 \text{ acres} = 33 \text{ percent}$

Calculate the percentage of surface area expansion resulting from the SWRR.

Step 5

$33 \text{ percent} \times 65 \text{ gpm} = 21 \text{ gpm (total)}$
 $33 \text{ percent} \times 21 \text{ gpm} = 7 \text{ gpm (standard deviation)}$

Calculate the potential increased WRCW flow based on Step 1 and 4.

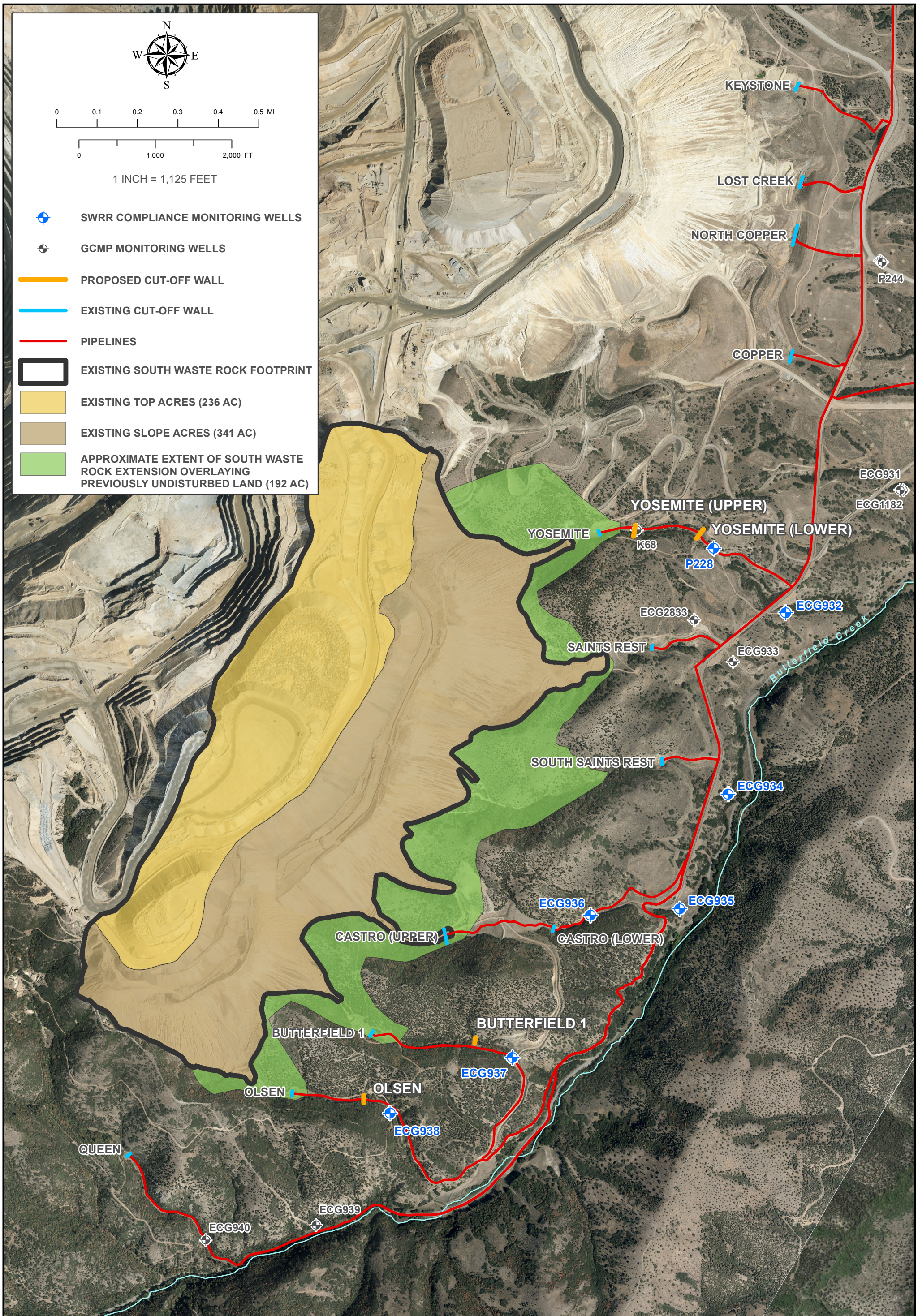

4.3.2 Estimate of Potential Discharge to Bedrock

A small volume of WRCW will likely migrate into bedrock. This section presents several lines of evidence and reasoning supporting the conclusion that the amount of WRCW potentially migrating into bedrock beneath the SWRR is likely to be a small fraction of the WRCW flow estimated in Section 4.3.1.

This section also presents an evaluation comparing the estimated potential WRCW seepage rate to bedrock with literature-based estimates of leakage from engineered, synthetic liners. This comparison supports the use of naturally-occurring low permeability sediments and rocks in conjunction with components of the BAT as practicable for capturing WRCW potentially generated in association with the SWRR.

The method of estimating potential seepage into bedrock used a simple mixing model based on the conservation of sulfate mass in the WRCW and bedrock aquifer. This model was based on methods included in Section 3.2 of the 1994 Permit Application (KUC, 1994) and subsequent permit modifications (most recent being KUC, 2013). The mixing model is used to anticipate the SWRR seepage rate into bedrock based on concentrations observed in the down-gradient monitoring wells. Illustration 4-3 provides an overview of the methods and assumptions employed in this mixing model.

ILLUSTRATION 4-3
Method of Estimating Waste Rock Discharge to Bedrock

Goal: Estimate the potential WRCW discharge to the ground.

Method: The calculation is based on the assumption that the impact to the aquifer from the SWRR would be a proportional increase above existing impacts, specifically, that it would increase based on the acreage of waste rock placed over currently undisturbed acreage. This is a conservative approach to estimating discharge rate and likely results in an over estimate based upon the fact that WRCW is no longer ponded along the toe of the waste rock dumps. The current WRCW flow to bedrock was calculated using a simple mixing model based on conservation of solute mass and basic hydrogeological principles. The potential future WRCW seepage was then estimated as a fraction of the current flow based on a ratio of surface areas, similar to the calculations shown in Illustration 4-2. This method provides a maximum estimate as it does not account for reductions that will result from new features of the SWRR (see Attachment 2).

Step 1

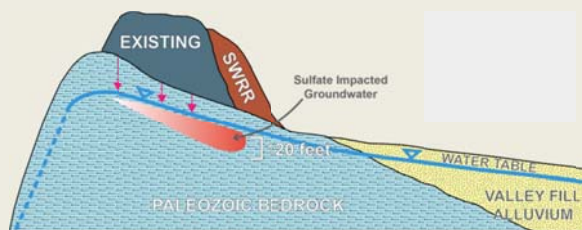

Estimate the depth of historical WRCW impacts to the bedrock underlying the existing waste rock dumps. This was done using data from SWRR compliance monitoring wells in bedrock to assess the depth of sulfate impacts above estimated background concentrations. The impacted thickness was estimated to be 120 feet.

ILLUSTRATION 4-3

Method of Estimating Waste Rock Discharge to Bedrock

Step 2

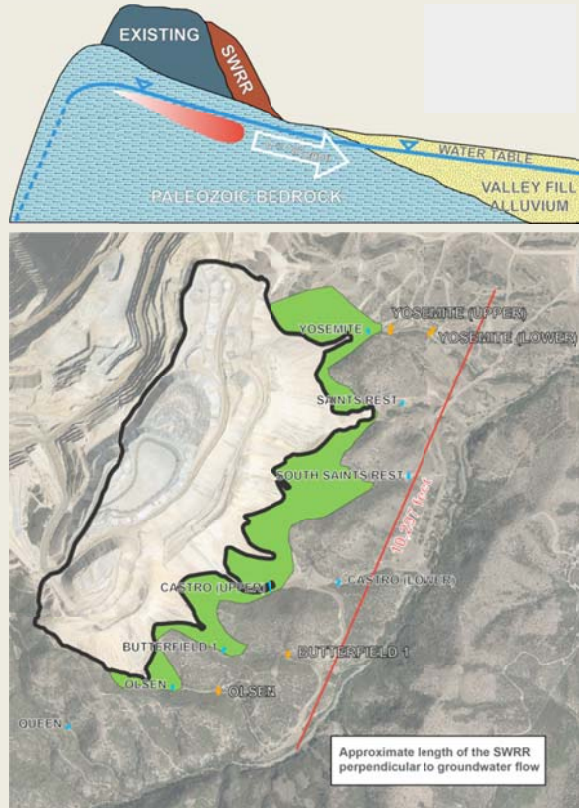

Estimate the current volumetric flux of sulfate impacted groundwater in bedrock east of the proposed SWRR using Darcy's Law (Freeze and Cherry, 1979). Values of hydraulic gradient were estimated from a current potentiometric surface map. Hydraulic conductivity was estimated as the geometric mean of values from permitted compliance monitoring wells in bedrock near the proposed SWRR. The cross sectional area of flow was estimated based on the 120-foot depth (Step 1) and the approximate length of the SWRR perpendicular to groundwater flow (10,297 feet). The estimated flow rate was 182 gpm.

$$Q = K i A \text{ (Darcy's Law)}$$

where: Q = flow rate (volume/time)

K = hydraulic conductivity (length/time)

i = hydraulic gradient (dimensionless)

A = cross sectional area of flow (area)

ILLUSTRATION 4-3

Method of Estimating Waste Rock Discharge to Bedrock

Step 3

$$C_1 \times Q_1 = C_2 \times Q_2$$

where:

C1 = 1,025 mg/L = Spatially-weighted/background-adjusted sulfate concentration in bedrock monitoring wells (Table 4-4)

Q1 = Calculated bedrock underflow derived from equation 1 = 182 gpm

C2 = Concentration of WRCW = 10,500 mg/L -the average concentrations of sulfate in the current South Dump WCS (Table 4-4)

Q2 = Flow of the concentrated leach water migrating into bedrock (17.8 gpm)

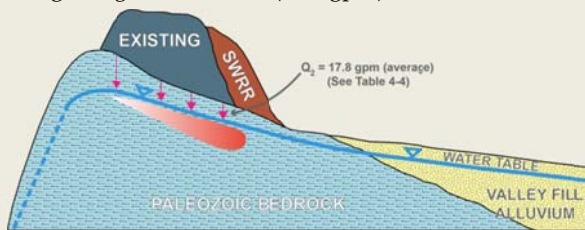

Use a simple mixing model to solve for the unknown – the flow of water migrating from the current waste rock dumps into the bedrock. The mixing model assumes conservation of sulfate mass where the mass flux of sulfate from the waste rock into the bedrock equals the mass flux of sulfate in the bedrock. The two sulfate concentration values were derived from (1) historical monitoring data in bedrock groundwater monitoring wells, and (2) monitoring data from the South Dump associated WCS.

Step 4

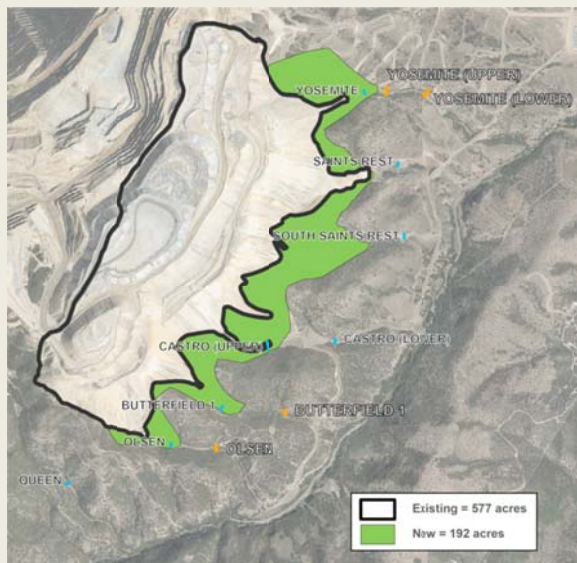

Calculate the percentage of surface area expansion resulting from the SWRR (see Illustration 4-2).

$$192 \text{ acres} \div 577 \text{ acres} = 33 \text{ percent}$$

Step 5

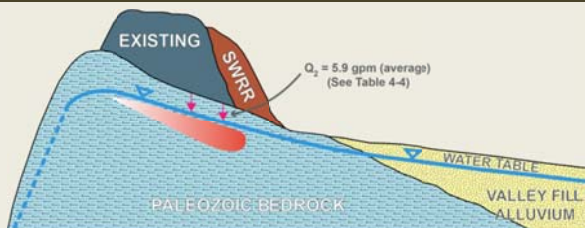

Calculate the increased WRCW seepage to bedrock due to the SWRR, based on Step 1 and Step 4.

$$33 \text{ percent} \times 17.8 \text{ gpm (average)} \approx 5.9 \text{ gpm}$$

The horizontal underflow in the upper portion of the bedrock can be calculated using groundwater flow principles. The equation used for groundwater flow is Darcy's Law (Freeze and Cherry, 1979):

EQUATION 1

$$Q = K i A$$

where: Q = flow rate (volume/time)
K = hydraulic conductivity (length/time)
i = hydraulic gradient (dimensionless)
A = cross sectional area of flow (area)

For the SWRR area, these parameters are as follows:

- **Hydraulic conductivity (K).** As noted in Section 3.3.1, the geometric mean is a good predictor of the effective bulk hydraulic conductivity in rock materials and is used for these calculations. The geometric mean hydraulic conductivity of Paleozoic and volcanic bedrock is 5×10^{-5} centimeters per second (0.14 foot per day).
- **Hydraulic gradient (i).** The horizontal hydraulic gradient to the east of the waste rock dumps is estimated to be 0.2 (dimensionless), based on the groundwater contours presented in Figure 4-1.
- **Cross sectional area (A).** The cross section through which groundwater flows is a vertical plane that runs roughly northeast to southwest through the proposed toe of the SWRR area along the line of the proposed gravity drain and cut-off wall system. The length of the proposed toe of waste rock is approximately 10,297 feet. The area of the vertical plane equals that length multiplied by the depth of flow of 120 feet, which was estimated from the thickness of sulfate-impacted groundwater.

Water quality (as characterized by sulfate concentration) for the monitoring wells drilled in the bedrock immediately downstream of the existing waste rock dump was used to estimate the depth of WRCW impacts in the principal aquifer. Monitoring wells with a saturated thickness greater than approximately 120 feet do not exhibit elevated sulfate concentrations above the maximum background concentration of 250 milligrams per liter (mg/L) (see Table 5-4 in Section 5.2). Based on this analysis, the saturated thickness for the impacted aquifer was conservatively assumed to be approximately 120 feet (see Figure 4-3). Using Equation 1 and the previously listed values, the maximum flux ("horizontal underflow") of water through the cross sectional area is approximately 24.3 cubic feet per minute (ft³/min), or approximately 182 gpm.

FIGURE 4-3
Sulfate Concentration with Saturated Thickness

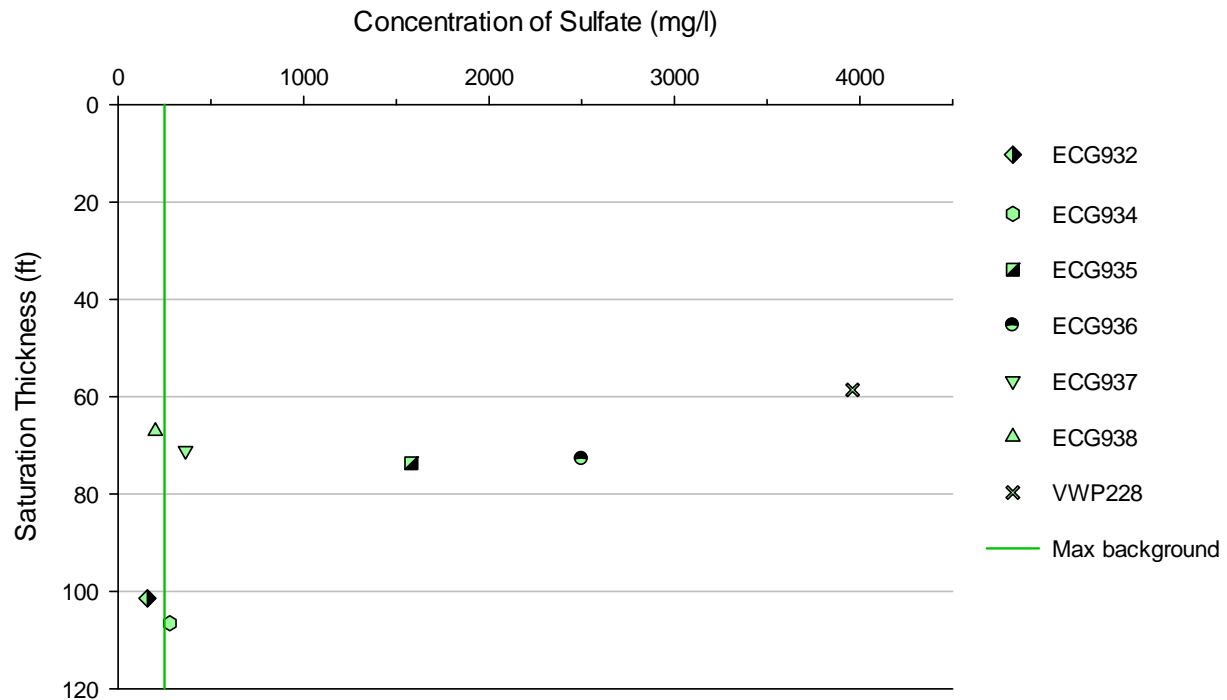

The second part of this estimate uses the mixing model and analytical results from water collected at the existing cut-off walls, which are then compared to the chemistry observed at the monitoring wells. The sulfate concentrations used in this equation use the average of a 15-year data set (1999 to 2014) (see Table 4-4).

The calculation was performed using the sulfate data because sulfate concentrations above background are a good indicator of WRCW impacts down gradient of the waste rock dumps. The calculation assumes that sulfate concentrations detected at the monitoring wells above background concentrations originate from the high concentration sulfate impacted by WRCW.

The equation for this calculation is as follows:

EQUATION 2

$$C_1 \times Q_1 = C_2 \times Q_2$$

where:

C_1 = Spatially-weighted and background-adjusted sulfate concentration at the monitoring wells = 1,025 mg/L. See the text below, Figure 4-4 and Table 4-4 for information supporting this calculation.

Q_1 = Calculated bedrock underflow derived from Equation 1 = 182 gpm

C_2 = Concentration of the captured leach water = 10,500 mg/L – the average concentrations of sulfate from WRCW collected in the South Dump WCS

Q_2 = Flow of WRCW potentially seeping into bedrock (gpm) per calculation = 17.8 gpm

The spatially-weighted/background-adjusted sulfate concentration was calculated as follows:

1. A northeast-southwest line was drawn down gradient of the bedrock monitoring wells shown on Figure 4-4 and listed in Table 4-4. This line is also roughly perpendicular to the groundwater flow direction in the principal aquifer.
2. A perpendicular line was drawn through the approximate mid-points between adjacent wells.
3. The distance between these midpoints (D_{well}) was tabulated (Table 4-4) and assigned to wells that fell between the mid-points. The total distance (D_{total}) was also tabulated.
4. A well-specific weighting factor was calculated by dividing D_{well} by D_{total} .
5. The well-specific weighting factors were then multiplied by the average measured sulfate concentration at a well to yield a spatially weighted concentration for each well.
6. The overall spatially-weighted concentration (1,275 mg/L) was then calculated by summing the values for each well
7. The spatially-weighted/background-adjusted sulfate concentration (1,025 mg/L) was calculated by subtracting 250 mg/L from the spatially-weighted concentration (1,275 mg/L). 250 mg/L is the upper end of background sulfate concentration in bedrock based on previous baseline investigations (see Table 5-4). Subtracting the background signature is deemed appropriate as concentrations below this value do not necessarily represent impact from overlying waste rock.

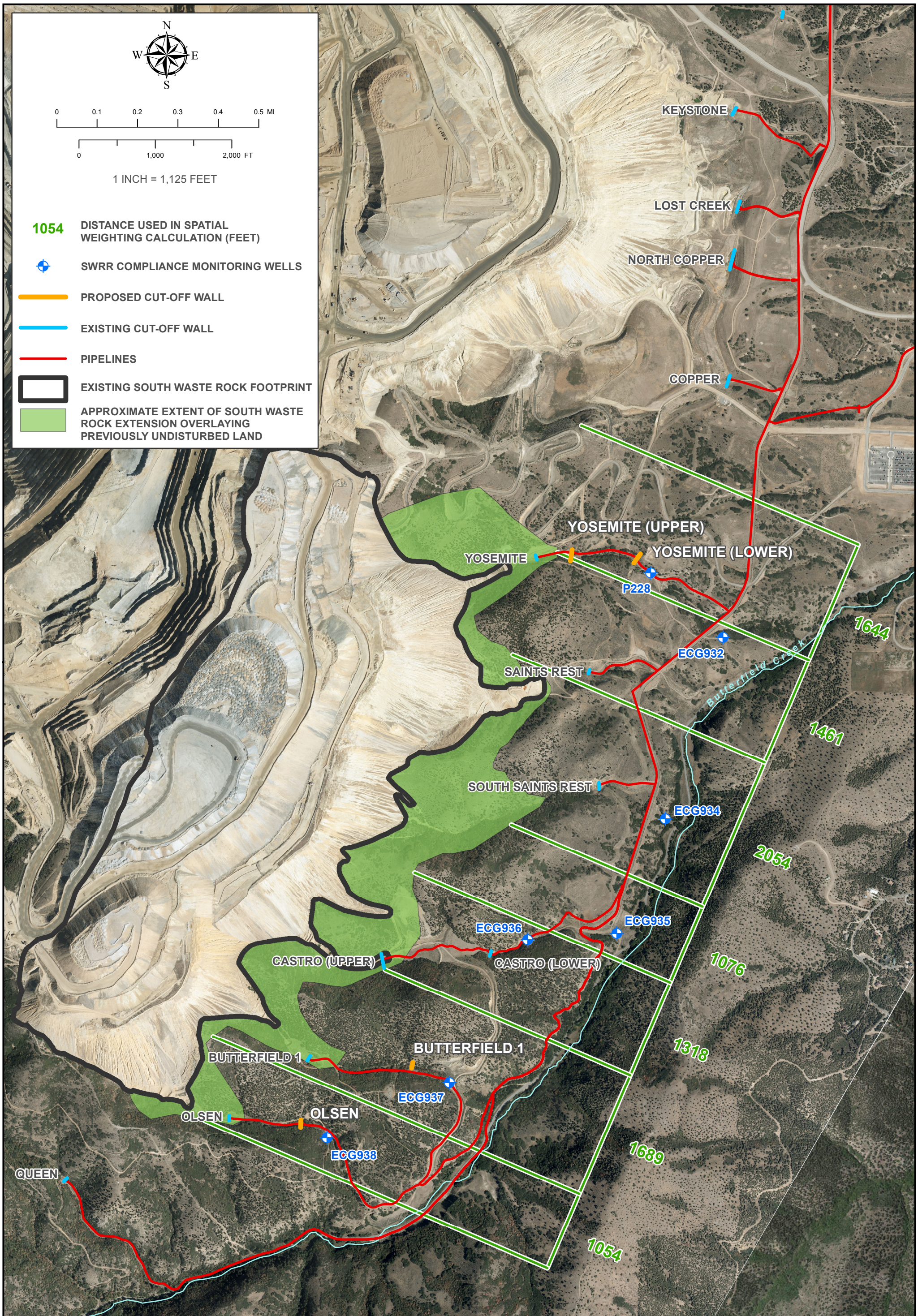

Using Equation 2 and the inputs described above, the resulting seepage from the waste rock to the bedrock for the current waste rock dump configuration is approximately 17.8 gpm. Using the 33 percent spatial weighting factor described previously, the average estimated increase in WRCW seepage from the SWRR is approximately 5.9 gpm. This potential seepage is approximately 3.2 percent of the estimated 182 gpm total WRCW discharge (see above). However, these calculations were based on sulfate concentrations observed in the monitoring wells that may reflect remnant impacts from before construction and operation of the WCS thereby biasing the estimate high.

TABLE 4-4
Spatial Weighting of Sulfate Concentration

Well ID	Length (ft)	Weighting Factor	Average Sulfate Concentration (mg/L)	Spatially Weighted Concentration (mg/L)
VWP228	1,644	0.16	3,960	632
ECG931	1,461	0.14	157	22
ECG932	2,054	0.20	279	56
ECG934	1,076	0.10	1,580	165
ECG935	1,318	0.13	2,500	320
ECG936	1,689	0.16	363	60
ECG937	1,054	0.10	200	20
ECG938	1,644	0.16	3,960	632
Total Length (ft):	10,297		Weighted Concentration:	1,275

NOTES:
mg/L = milligram(s) per liter

As part of the effort to identify the BAT for controlling impacts to the regional aquifer, the seepage flux estimates provided above were compared to allowable leakage rates for synthetic liners. A technical memorandum written for the EWRE is provided as Appendix C, evaluating synthetic-liner allowable leakage rates based on studies published by government and industry sources. The 5.9 gpm WRCW seepage rate estimated above is an order of magnitude lower than rates allowed for comparable sized landfills and waste piles across multiple states in the United States. When considering liner constructability issues related to the SWRR project area, the leakage rates for a synthetic liner are anticipated to be even higher than those identified for the idealized cases. Based on this evaluation, the naturally-occurring, high surface gradient, low-permeability surface at the top of bedrock provides much better performance than would be expected from a synthetic liner and is included as part of the BAT for managing WRCW for the SWRR project.

The 5.9 gpm estimated seepage rate based upon the mass-balance/mixing model is a reasonable and conservative approximation for the purpose of completing Part B of the Permit application. This value is likely overestimated since it does not account for: (1) all of the system components described in Attachment 2, such as the surface and subsurface (or alluvial) collection system; (2) losses of precipitation to storm water run-off; and (3) the degree of water-consuming mineralization reactions that will occur in the fresh waste rock with abundant reaction sites. Considering these factors, the actual seepage of WRCW due to the SWRR is likely to be lower than 5.9 gpm. In addition, the SWRR will reduce WRCW formation and seepage from existing waste rock as the SWRR encapsulates approximately 341 acres of the existing dump slopes where advanced infiltration limiting controls are not currently employed.

5.0 Groundwater Quality

5.1 Recent Compliance Monitoring Results

Compliance groundwater samples for the ECS are collected in accordance with the current KUC Groundwater Characterization and Monitoring Plan (GCMP). This section provides an overview of recent groundwater compliance monitoring results for those wells associated with the SWRR. A total of 7 compliance monitoring wells from the SWRR were sampled and analyzed in 2014 in association with Groundwater Discharge Permit No. UGW350010. Recent (2014) analytical results from these wells are presented in Table 5-1.

Mann-Kendall trend analyses were performed using analytical data from January 1998 to summer/fall 2014 for the 7 compliance wells hydraulically down gradient of the proposed SWRR. The Mann-Kendall trend analysis was run at the 90 percent confidence interval and identifies a trend as either increasing or decreasing. If the coefficient of variation is equal to or less than 1, there is no trend and the time series data is labeled “stable.” Time series plots for the compliance wells and other monitoring wells in the vicinity are included as Appendix A.

Applicable permit water quality limits for each well can be found in Table 5-2. Table 5-3 summarizes data analysis of compliance monitoring results including trends (Mann-Kendall analysis) and comparisons with compliance limits. Table 5-4 summarizes baseline (i.e., unaffected by historical WRCW) water quality data for the principal aquifer.

The combined average sulfate and TDS trends from SWRR down gradient compliance wells are shown in Table 5-5. Sulfate and TDS were considered together because sulfate is a major component of TDS. This analysis uses current compliance limits to simplify the analysis; however, compliance limits have changed over time. Time-averaged concentrations are below current compliance limits for each of the compliance wells.

Cases with only historical exceedances are of less importance in assessing current WRCW impacts on the regional aquifer. This is because the current overall concentration trend when concentrations are averaged across all wells is downward (see Figure 5-1). Therefore, sporadic historical exceedances do not indicate long-term potential for compliance limit exceedances.



THIS PAGE INTENTIONALLY LEFT BLANK

TABLE 5-1
Compliance Well Water Quality

Station	Date of Last Sample	Total Dissolved Solids (mg/L)	pH	Sulfate (mg/L)	Cadmium (mg/L)	Copper (mg/L)	Zinc (mg/L)	Magnesium (mg/L)	Chloride (mg/L)	Screen Location
ECG932	9/9/2014	790	7.21	157	<0.001	<0.02	<0.01	53	137	Bedrock
ECG934	8/28/2014	870	6.9	279	<0.001	<0.02	<0.01	51	87	Bedrock
ECG935	8/28/2014	3180	6.89	1580	<0.001	<0.02	<0.01	194	192	Bedrock
ECG936	8/13/2014	4130	6.55	2500	<0.001	<0.02	<0.01	290	260	Bedrock
ECG937	8/15/2014	1070	6.84	363	<0.001	<0.02	<0.01	47	160	Bedrock
ECG938	8/15/2014	804	7.01	200	<0.001	<0.02	<0.01	47	127	Bedrock
VWP228	7/15/2014	6010	6.01	3960	0.011	0.077	1.095	832	192	Alluvium

NOTES:

mg/L = milligram per liter

TABLE 5-2
Water Quality Standards for Compliance Monitoring Wells

Well ID	Screen Lithology	Sampling Frequency	NAD 83		pH	TDS (mg/L)	SO ₄ (mg/L)	Diss. Cd (mg/L)	Diss. Cu (mg/L)	Diss. Zn (mg/L)
			Latitude (Decimal Degrees)	Longitude (Decimal Degrees)						
ECG932	Bedrock	Semiannually	40.5108910	-112.1063874	6.5-8.5	796	164	0.001	0.325	1.25
ECG934	Bedrock	Semiannually	40.504369	-112.109028	6.5-8.5	1,157	449	0.001	0.325	1.25
ECG935	Bedrock	Semiannually	40.500235	-112.111263	6.47-8.5	4,771	2,794	0.003	0.650	2.50
ECG936	Bedrock	Semiannually	40.499979	-112.115456	6.36-8.5	5,159	3,160	0.003	0.650	2.50
ECG937	Bedrock	Semiannually	40.494483	-112.119090	6.5-8.5	1,359	476	0.001	0.325	1.25
ECG938	Bedrock	Semiannually	40.492896	-112.124032	6.5-8.5	1,016	266	0.001	0.325	1.25
VWP228	Alluvium	Quarterly	40.5131827	-112.1098041	5.5-8.5	11,173	7,721	0.064	0.650	4.74

NOTES:

All units are mg/L; pH standard units

mg/L = milligrams per liter

TDS = total dissolved solids

SO₄ = sulfate

Diss. Cd = dissolved cadmium

Diss. Cu = dissolved copper

Diss. ZN = dissolved zinc

¹Compliance Limits are based on 1.25 times the background concentration for TDS for Class II and III groundwater.

²For many wells cadmium, copper, and zinc were predominantly nondetects; compliance limits determined from the groundwater quality standard.

³Where the background concentrations is less than detection, compliance limits are based on 0.25 times the groundwater quality standard for Class II groundwater and 0.50 times the groundwater quality standard for Class III groundwater for cadmium, copper, and zinc.

⁴If background value exceeds the groundwater quality standard, the Protection Level equals the background value.

⁵The Compliance Limits for Class IV groundwater are the higher of the groundwater quality standard, the mean times 1.25, or the mean + 2 std. dev.

⁶There is not a groundwater quality standard for sulfate.

⁷Compliance limits for sulfate were calculated as the higher of the mean+2 std. dev. or 1.25 times the mean.

⁸Range of pH values for Compliance Limits are based on the higher and lower limit of 6.5-8.5 and/or mean + and -2 std. dev.

⁹Coordinate system in KUC True North south end map drawn in 1927 State Plane Utah Central Zone.

¹⁰Limits were set using all available data for each individual well through 2008.

TABLE 5-3A
 Compliance Monitoring Data Analysis Summary¹

Analyte	Count of Compliance Wells by Trend ¹				Well with Increasing Trends ¹ within 25% of Current Compliance Limit	Wells with Compliance Limit Exceedances ¹ (Data set spanning January 1999 to September 2014)
	Insufficient Detections	Decreasing	Stable	Increasing		
Total Dissolved Solid	0	5	1	1	---	None
Sulfate	0	6	0	1	ECG932	None
Copper	7	1	0	0	---	None
Zinc	2	2	1	2	---	None
Cadmium	7	1	0	0	---	None

NOTES:

Compliance limits use the limits established as part of the 2010 Permit renewal (DWQ, 2010).

¹Based on compliance monitoring data between January 1998 and September 2014 for wells VWP228, ECG932 and ECG934 through ECG938 all within the SWRR area. Based on Mann-Kendall analysis. See text for further discussion.

TABLE 5-3B
 Compliance Monitoring pH Analysis Summary¹

Analyte	Count of Compliance Wells by Trend ¹				Wells with Increasing H+ ion Trends ¹ within 25% of Current Compliance Limit (Decreasing pH)	Wells with pH out of Compliance Range ¹ (Data set spanning January 1998 to Sept 2014)
	Insufficient Detections	Decreasing H+ ion (Increasing pH)	No Trend	Increasing H+ ion (Decreasing pH)		
pH (analysis based on hydrogen ion concentration)	0	2	5	0	----	None

NOTES:

Compliance limits use the limits established as part of the 2010 Permit renewal (DWQ, 2010).

¹Based on compliance monitoring data between January 1998 and Sept 2014 for wells VWP228, ECG932 and ECG934 through ECG938. Based on Mann-Kendall analysis. See text for further discussion.

TABLE 5-4
Baseline Water Quality of Principal Aquifer

Parameter	Range	Typical Value
Arsenic	<0.004–0.03	0.005
Cadmium	<0.001–0.02	0.005
Chromium	<0.002–0.010	0.005
Copper	0.006–0.10	0.02
Lead	0.001–0.015	0.005
Selenium	<0.002–0.010	0.005
Sulfate	10–250	150
TDS	325–1,200	650
pH (units)	7.0–8.1	7.5

NOTES:

All values in mg/L except pH

mg/L = milligrams per liter

TDS = total dissolved solids

Source: KUC, 1992; ABC/ASCI, 1990; Kennecott Environmental Laboratory (KEL), 1993

FIGURE 5-1
Annual Average Sulfate and TDS in Compliance Wells

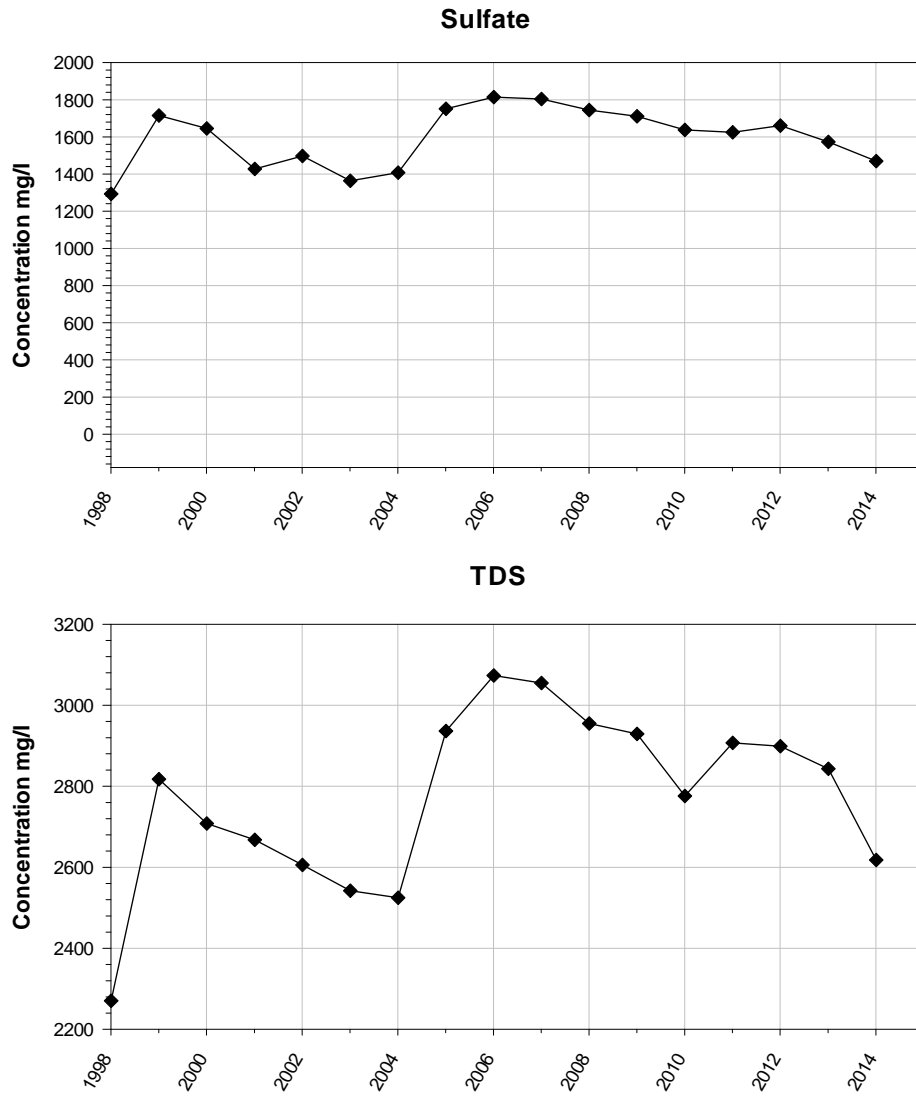

The following discussion focuses on wells with current compliance limit concentration trends suggesting the potential for future exceedances. The compliance wells considered are those down gradient of the SWRR and include ECG932, ECG934 through ECG938 and VWP928. Wells with only historical exceedances, but not current exceedances or trends approaching compliance limits, are not discussed. However, such wells have been discussed in periodic monitoring reports and related technical documents.

No compliance wells currently exceed their respective TDS or sulfate compliance limits (Appendix A).

Compliance well ECG932 appears to exhibit a slight upward trend in sulfate on the linear scale plots shown in Appendix A of this Attachment, confirming the Mann-Kendall results (see Table-3A).

The remaining analytes (copper, cadmium, and zinc) exhibit neither recent exceedances nor trends approaching their well-specific compliance limits.

The conclusion from review of the compliance monitoring results includes:

- Installation, operation, and maintenance of the WCS is effectively protecting drinking water resources in the principal alluvial aquifer.

5.2 Baseline Water Quality of the Principal Aquifer

The 1990 baseline water quality of the principal aquifer was described in KUC (1992) and the 1994 permit Notice of Intent (NOI). For the purposes of providing a basis for evaluating the groundwater quality in wells in the vicinity of the WCS, baseline water quality is defined as groundwater quality that would exist in the southwestern Jordan Valley had there been no anthropogenic changes or natural erosion of the Bingham ore body (KUC, 1994). See Table 5-4 for baseline water quality in the principal aquifer.

5.3 Applicable Groundwater Class

The groundwater of the southwestern edge of the Jordan Valley is not classified. However, numerous water quality studies in the area have been conducted by KUC. Based on these analyses, groundwater in the principal aquifer adjacent to the SWRR could be classified as Class II groundwater per Utah Administrative Code (UAC) R317-6-3. DWQ has specified Class II groundwater as drinking water quality. Class II groundwater is characterized by having TDS greater than 400 mg/L and less than 3,000 mg/L, and does not have contaminant concentrations exceeding groundwater quality standards as established in Table 1 of R317-6-2.1.



THIS PAGE INTENTIONALLY LEFT BLANK

6.0 References

- Adrian Brown Consultants, Inc. and Adrian Smith Consulting, Inc. (ABC/ASCI). 1990. *Bingham Creek Groundwater Remediation Program: Contractor Report to Kennecott Corporation*. November, 50 p.
- CH2M HILL. 2014. *South End Dump Reclamation Project Cut-off Wall Field Investigation Technical Memorandum*. September.
- CH2M HILL. 2012. *Cut-off Wall Field Investigation and Design Optimization Technical Memorandum*. 31 May.
- Chou, I-Ming, R.R. Seal II, and B.S. Hemingway. 2002. *Determination of Melanterite-Rozenite and Chalcantite-Bonattite Equilibria by Humidity Measurements at 0.1 MPa*, American Mineralogist, Volume 87, pages 108–114. University of Nebraska – Lincoln, DigitalCommons@University of Nebraska – Lincoln, accessed at: <http://www.google.com/url?sa=t&rct=j&q=&esrc=s&frm=1&source=web&cd=1&ved=0CCIQFjAA&url=http%3A%2F%2Fdigitalcommons.unl.edu%2Fcgi%2Fviewcontent.cgi%3Farticle%3D1340%26context%3Dusgsstaffpub&ei=eZR XUPO OeqQ2AWY3IHgAQ&usq=AFQjCNGFrW77GEskbA33u4BbKdVd71hLhg&sig2=9tp2HW7knlH3e68q1dcCSg>.
- Crittenden, M.D., Jr. 1964. *General geology of Salt Lake County: in Geology of Salt Lake County, Utah*; Geological and Mineralogical Survey Bulletin 69, pp. 11–48.
- Crittenden, M.D., Jr. 1977. *Stratigraphic and Structural Setting of the Cottonwood Area, Utah*: in Hill, J.G., ed., *Symposium on Geology of the Cordilleran Hingeline*, Rocky Mountain Association of Geologists, Denver, Colorado. pp. 363–379.
- Dames & Moore. 1988. *Milestone Report I, Data Base Synthesis: Mathematical Model of Ground Water Conditions, Southwestern Salt Lake County, Utah: Contractor report to Kennecott Utah Copper*. May, 1988, 64 p.
- Dames & Moore. 1989. *Ground Water Model, Southwestern Salt Lake County, Utah: Contractor Report for Kennecott Utah Copper*, No. 1375-069-31. February, 36 p.
- Davis, F.D. 1983a. *Geologic Map of the central Wasatch Front, Utah: Utah Geological and Mineral Survey*, Map 54-A, Wasatch Front Series, Salt Lake City.
- Davis, F.D. 1983b. *Geologic Map of the southern Wasatch Front, Utah: Utah Geological and Mineral Survey*, Map 55-A, Wasatch Front Series, Salt Lake City.
- Freeze, R. and Cherry, J. 1979. *Groundwater*, Prentice Hall, Inc, Upper Saddle River, New Jersey.
- Kennecott Utah Copper. 1991. *Geologic Map of the Bingham District*: Bingham District Guidebook Plate 1, Mapping by Kennecott Staff. Compilation by A.J. Swensen, 1975 and 1978; Kennecott staff, 1991.
- Kennecott Utah Copper. 1992. *Groundwater Assessment Report of the Southeastern Jordan Valley Area*: Report by Kennecott Utah Copper and Adrian Brown Consultants, Inc. 28 July, 131 pp.
- Kennecott Environmental Laboratory (KEL). 1993. *Water Quality Database for Ground Water and Surface Water in the Jordan Valley*: Kennecott Corporation, Digital Database.
- Kennecott Utah Copper. 1994. *Eastside Collection Monitoring System Groundwater Discharge Permit Application, Revision 1*. June 1994, pp 32–37.

-
- Kennecott Utah Copper. 2007a. *Short Term Pump Test and Historic Review of Out of Compliance Well ECG907, KUCC Groundwater Discharge Permit #UGW350010, Memo to UDEQ DWQ*. 5 June.
- Kennecott Utah Copper. 2007b. *Short Term Pump Test and Historic Review of Out of Compliance Well ECG1187 for KUCC Groundwater Discharge Permit #UGW350010, Memo to UDEQ DWQ*. 10 July.
- Kennecott Utah Copper. 2012. *2011 Annual Report, Bingham Canyon Mine and Water Collection System Groundwater Discharge Permit #UGW250010*. April.
- Kennecott Utah Copper. 2013. *Kennecott Utah Copper Bingham Canyon Mine and Water Collection System, EWRE Groundwater Discharge Permit UGW350010 Modification*. May.
- Kennecott Utah Copper. 2014. *Groundwater characterization and monitoring plan, Kennecott Utah Copper, Magna, Utah*. September.
- Lund, W.R., G.E. Christenson, K.M. Harty, S. Hecker, G. Atwood, W.F. Case, H.E. Gill, J.W. Gwynn, R.H. Klauk, D.R. Mabey, W.E. Mulvey, D.A. Sprinkel, B.T. Tripp, B.D. Black, and C.V. Nelson. 1990. *Geology of Salt Lake City, Utah, United States of America: Bulletin of the Association of Engineering Geologists*, v. 27, n. 4, pp+. 391–478.
- Miller, R.D. 1980. Surficial geologic map along part of the Wasatch Front, Salt Lake Valley, Utah: U.S. Geological Survey Miscellaneous Field Studies Map MF-1198, 1:100,000.
- O’Kane Consultants. 2012. *Evaluation of Cover System Design Alternatives for East Waste Rock Extension at Kennecott Utah Copper Phase 2: Cover Design Numerical Modeling, Report No. 743/4-02*. May.
- Presnell, R.D. 1992. *Local And Regional Geology of The Oquirrh Mountains: in* Wilson, J.R., *ed.*, Field Guide to Geologic Excursions in Utah and Adjacent Areas of Nevada, Idaho, and Wyoming, Miscellaneous Publication 92-3, Utah Geological Survey, pp. 293–306.
- Salt Lake County. 1991. *Streamflow and Precipitation Data Report, Jordan River and tributaries*.
- Slentz, L.W. 1955a. *Salt Lake Group in Great Salt Lake Basin: The University of Utah, Department of Geology, PhD Dissertation*, 155 p.
- Slentz, L.W. 1955b. *Salt Lake Group in Lower Jordan Valley, Utah: in* A. J. Eardley, *ed.*, *Tertiary and Quaternary Geology of the eastern Bonneville Basin, Utah*, Utah Geological and Mineralogical Survey Guidebook to the Geology of Utah, no. 10, pp. 23–36.
- Smith, W.H. 1961. *The Volcanics of the Eastern Slopes of the Bingham District, Utah: In* D.R. Cook, *Ed.*, *Geology of the Bingham Mining District and Northern Oquirrh Mountains*, Utah Geological and Mineralogical Survey Guidebook to the Geology of Utah, no. 16, pp. 101–119.
- Smith, W. H. 1975. *General Structural Geology of the Bingham Mining District: in* R.E. Bray and J.C. Wilson, *Eds.*, *Guidebook to the Bingham Mining District*, Society of Economic Geologists, pp. 41–48.
- Stewart, J.H. 1978. *Basin-Range structure in western North America: A review: in* R.B. Smith and G.P. Easton, *eds.*, *Cenozoic Tectonics and Regional Geophysics of the western Cordillera*, Geological Society of America Memoir 152, pp. 1–31.
- Swayze, Gregg A., George A. Desborough, Kathleen S. Smith, Heather A. Lowers, Jane M. Hammarstrom, Sharon F. Diehl, Reinhard W. Leinz, and Rhonda L. Driscoll In. 2008. *Understanding Contaminants Associated with Mineral Deposits*, Edited by Philip L. Verplanck, U.S. Geological Survey Circular 1328, Chapter B: Understanding Jarosite—From Mine Waste to Mars accessed

at:

http://www.google.com/url?sa=t&rct=j&q=&esrc=s&frm=1&source=web&cd=1&ved=0CCIQFjAA&url=http%3A%2F%2Fspeclab.cr.usgs.gov%2FPAPERS%2Fjarosite_circular08%2Fusgs_circular_1328_jarosite_chapterB.pdf&ei=HjXUIfgKqSd2QXKqoGACA&usg=AFQjCNEzMA_UmK5AiCAPD3-H744a7l8keg&sig2=eDhbebgclSt3gpM3ZWwJsw

- Swensen, A.J., 1975, *Geologic Map of the Bingham District*, Kennecott Copper Corporation, Utah Copper Division, Geology Department, Figure 2.
- Utah Department of Environmental Quality (UDEQ). 1991. *Administrative Rules for Ground Water Quality Protection: R317-6*, Utah Administrative Code, State of Utah, Division of Water Quality. May 15.
- Utah Department of Environmental Quality (UDEQ). 1992. *Draft Revisions to the Administrative Rules for Ground Water Quality Protection: Draft to Utah Water Quality Board, State of Utah*. June 1.
- U.S. Environmental Protection Agency (USEPA). 1989. *Statistical Analysis of Ground Water Monitoring Data at RCRA Facilities, Interim Final Guidance: USEPA Interim Final Guidance Document*. February.
- Utah Department of Environmental Quality, Division of Water Quality (DWQ). 2010. *Groundwater Discharge Permit No. UGW350010, Bingham Canyon Mine, Eastside Collection Monitoring Network*. March.
- Warren, Ronald W., Thomas E. Hakonson, and Kenneth V. Bostick. 1996. *The Hydrologic Evaluation of Four Cover Designs for Hazardous Waste Landfills at Hill Air Force Base, Federal Facilities*. Environmental Journal. Winter 1995/96.
- WP Natural Resource Consulting, Inc. (WPNRC). 2011. *Waters of the U.S. Jurisdictional Assessment for the Bingham Canyon Mine*. Prepared for Kennecott Utah Copper LLC and U.S. Army Corps of Engineers. September.
- Younger, Paul L., Steven A. Banwart, and Robert S. Hedin. 2002. *Mine Water Hydrology, Pollution, Remediation*. Kluwer Academic Publishers, Dordrecht, the Netherlands.
- Zoback, M.L. 1983. *Structure and Cenozoic Tectonism Along the Wasatch Fault Zone, Utah*: in Miller, D.M., V.R. Todd and K.A. Howard, eds., *Tectonic and Stratigraphic Studies in the Eastern Great Basin*, Geological Society of American Memoir 157, pp. 3-27.





THIS PAGE INTENTIONALLY LEFT BLANK

Drawings/Geological Cross Sections

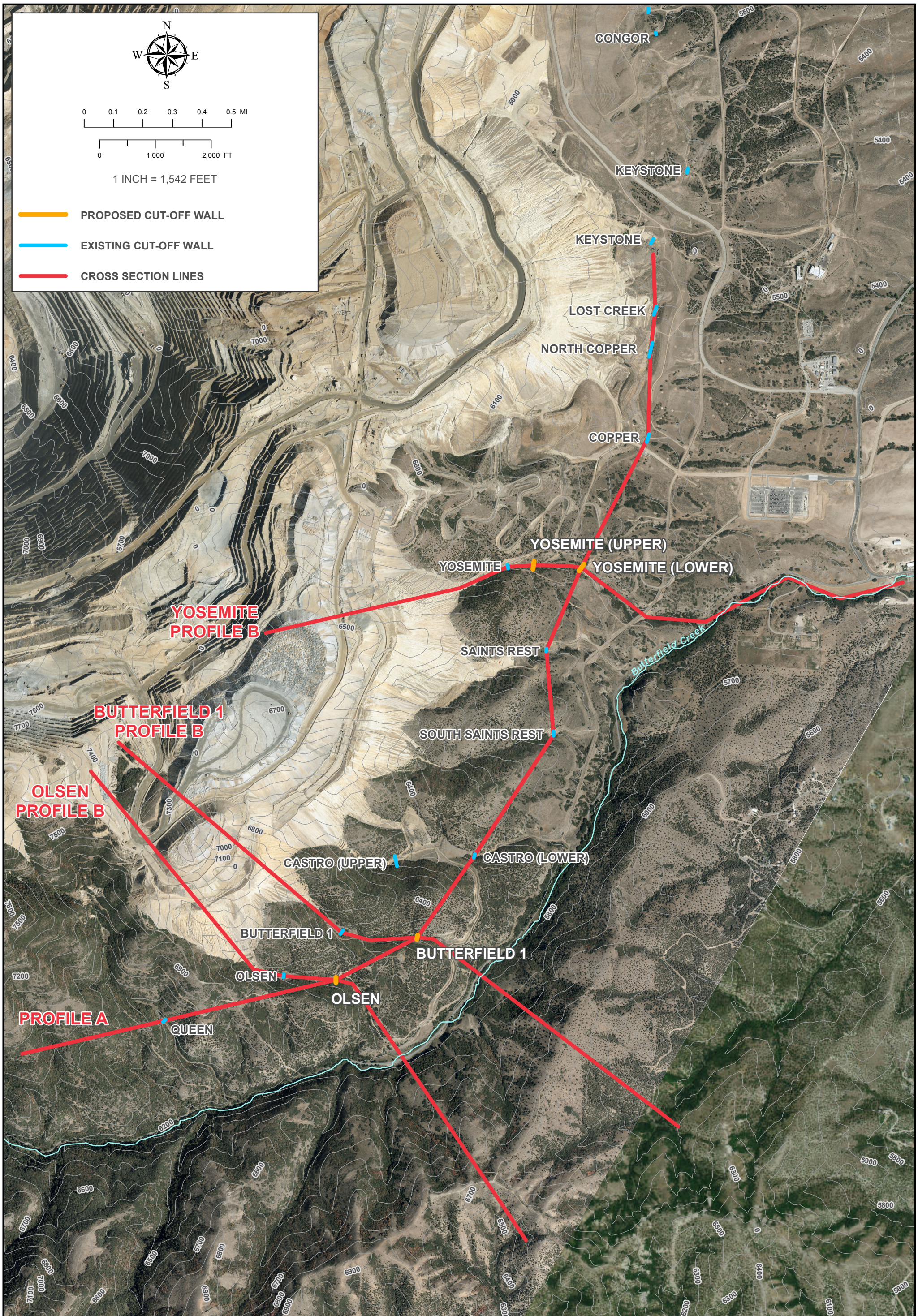

THIS PAGE INTENTIONALLY LEFT BLANK



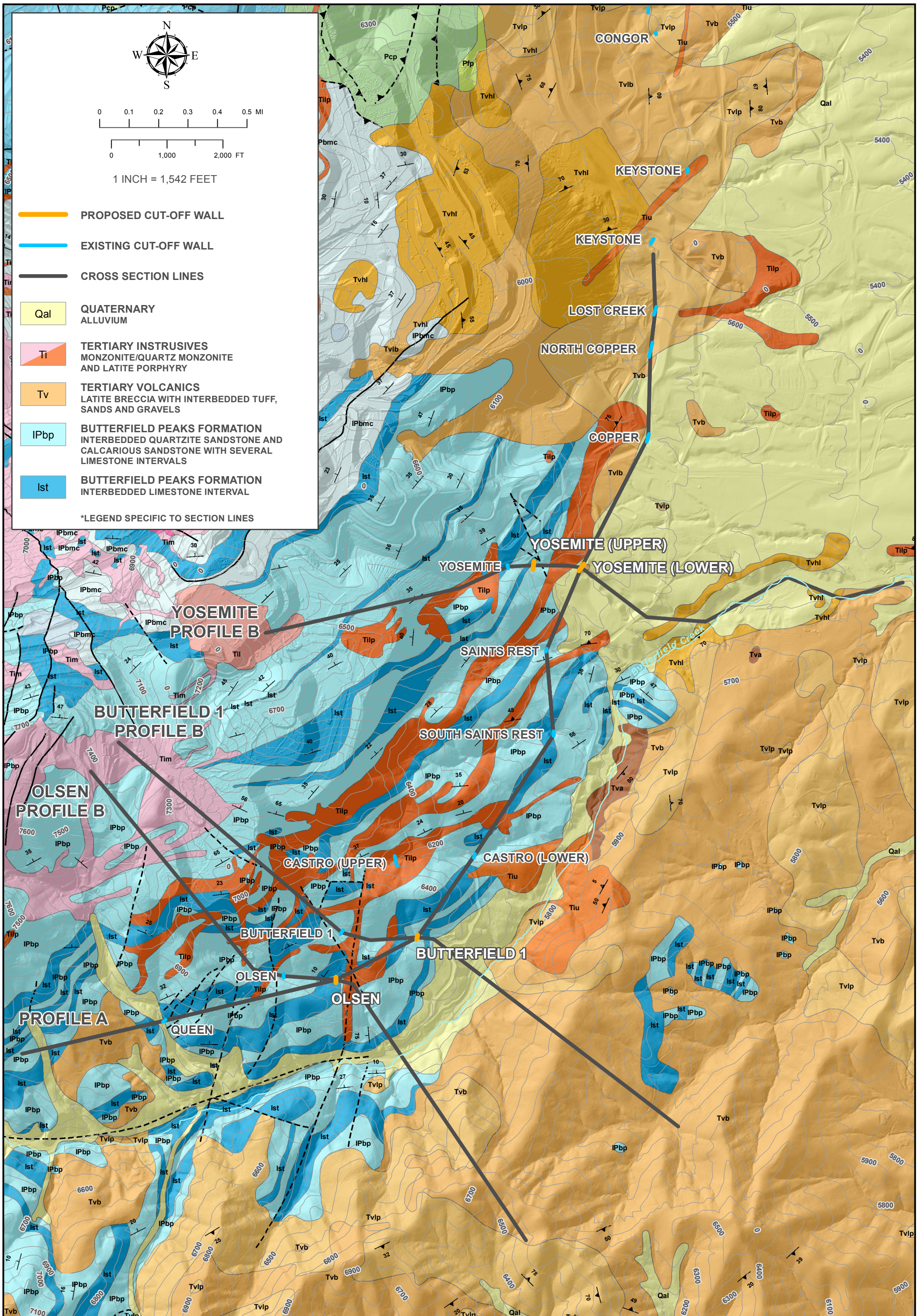

 0 0.1 0.2 0.3 0.4 0.5 MI
 0 1,000 2,000 FT
 1 INCH = 1,542 FEET
 PROPOSED CUT-OFF WALL
 EXISTING CUT-OFF WALL
 CROSS SECTION LINES

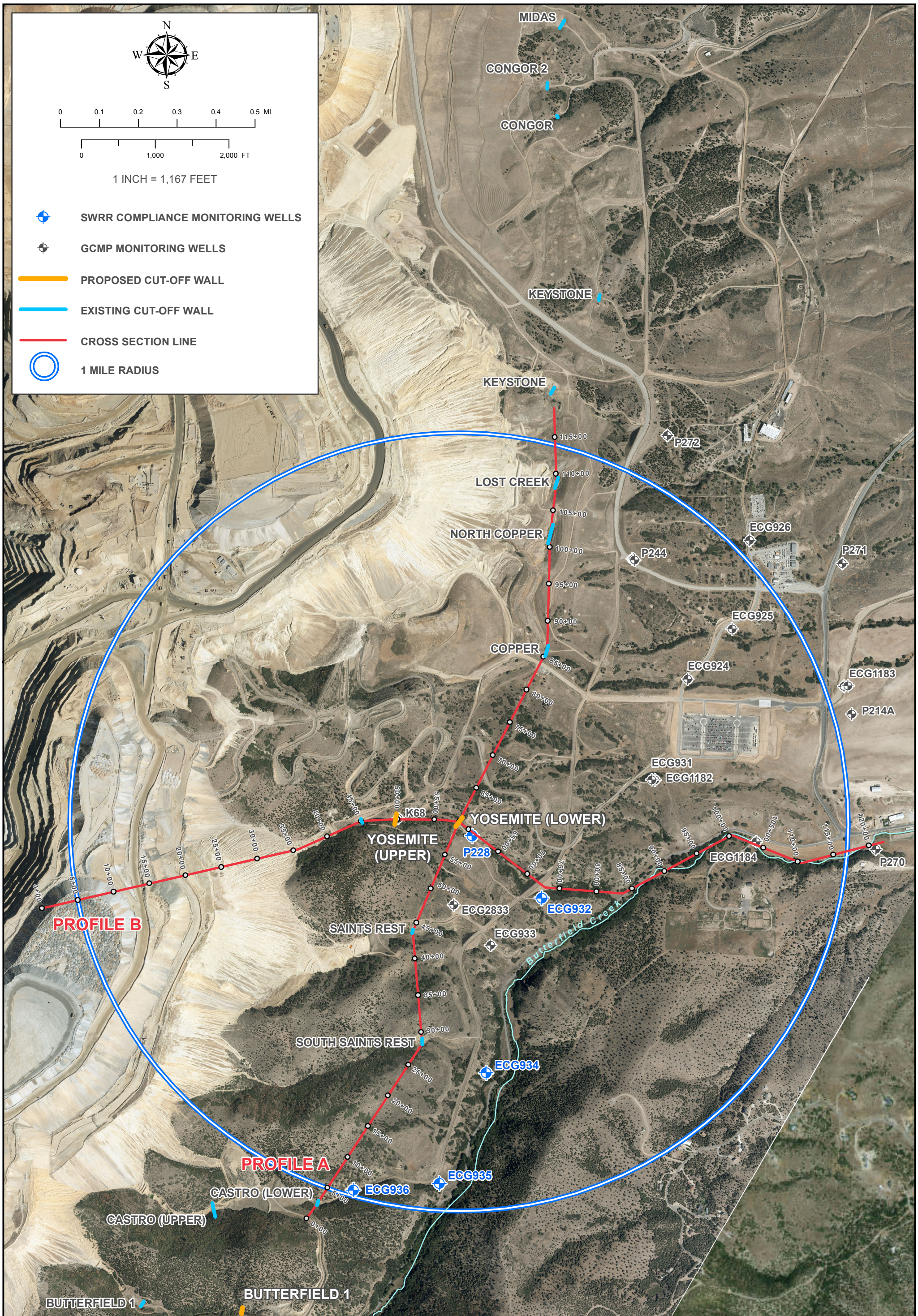

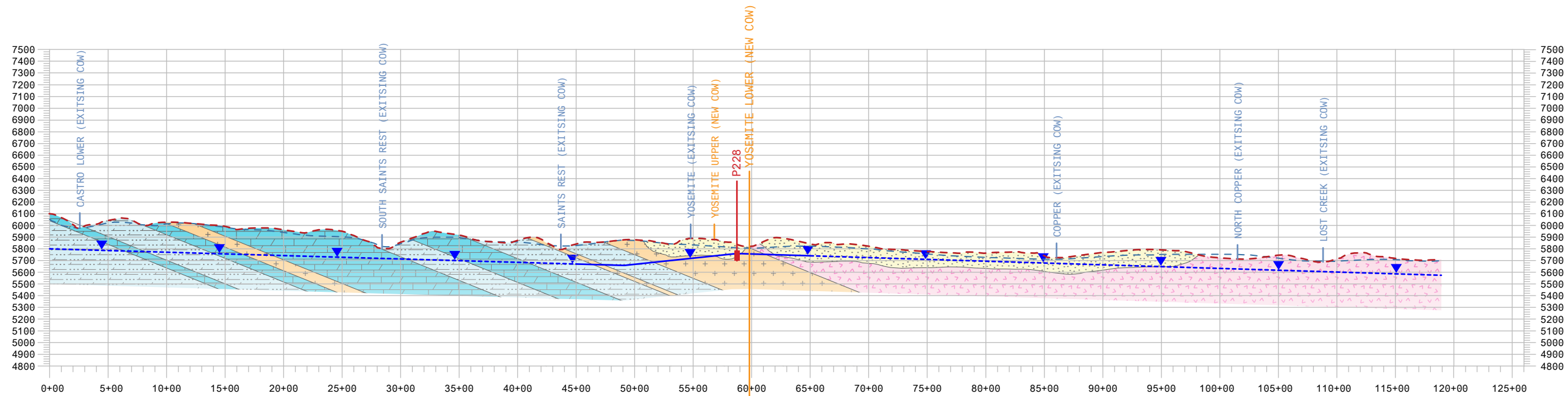

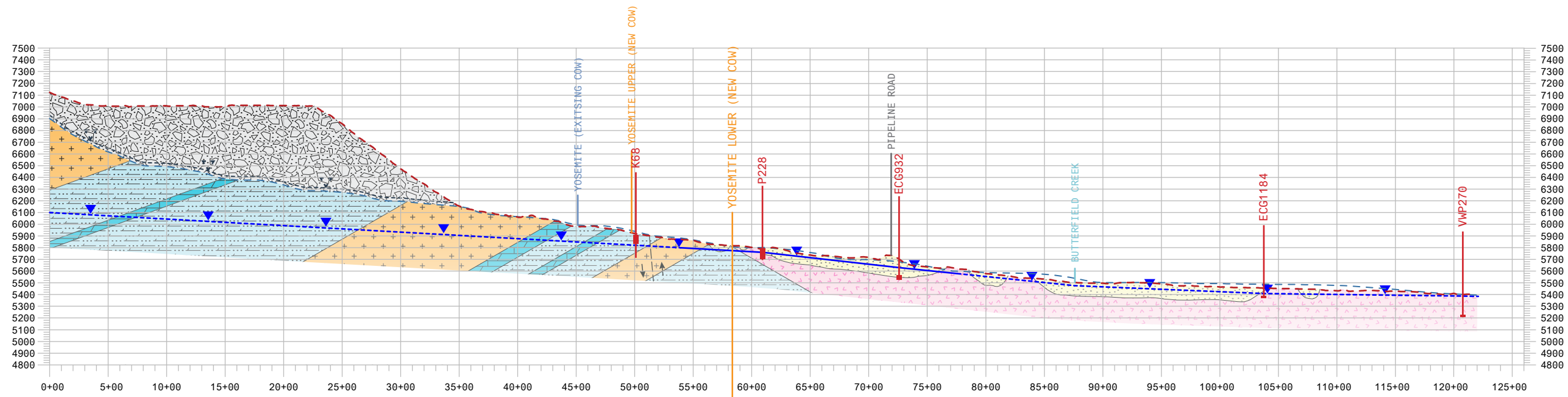
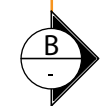

A PROFILE A
 HZ: 1" = 500', VT: 1"=500'
 LOOKING WEST



B PROFILE B
 HZ: 1" = 500', VT: 1"=500'
 LOOKING NORTH

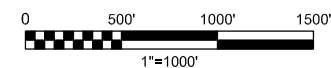
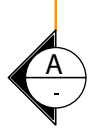

Drawing No. 4

RIO TINTO KENNECOTT COPPER

**YOSEMITE DRAINAGE AREA
 GEOLOGIC CROSS SECTIONS**

SOUTH WASTE ROCK RECLAMATION PROJECT



MONITOR WELL LOC ID	SCREEN INTERVAL (ft bgs)	TOTAL DEPTH OF BORING (ft bgs)	ELEVATION OF GROUND SURFACE (ft amsl)	WATER SURFACE ELEVATION (ft amsl)
K68	10-80	200	5916	
P228	?-84	90	5785	5760
ECG932	147-187	190	5713	5630
ECG1184	60-80	81	5451	5408
VPW270	179-199	199	5403	5385

LEGEND

- WASTE ROCK DUMP
- TERTIARY VOLCANICS
LATITE BRECCIA WITH INTERBEDDED TUFF, SANDS AND GRAVELS
- TERTIARY INTRUSIVES
MONZONITE/QUARTZ MONZONITE AND LATITE PORPHYRY
- BUTTERFIELD PEAKS FORMATION
INTERBEDDED QUARTZITIC SANDSTONE & CALCARIOUS SANDSTONE WITH SEVERAL LIMESTONE INTERVALS
- BUTTERFIELD PEAKS FORMATION
INTERBEDDED LIMESTONE INTERVAL

- MONITORING WELL
- CURRENT TOPOGRAPHY
- PRE-DUMP TOPOGRAPHY
- FAULT
- BEDROCK GROUNDWATER TABLE (DASHED WHERE INFERRED)
- SATURATED ZONE IN WASTE ROCK (DASHED WHERE INFERRED)

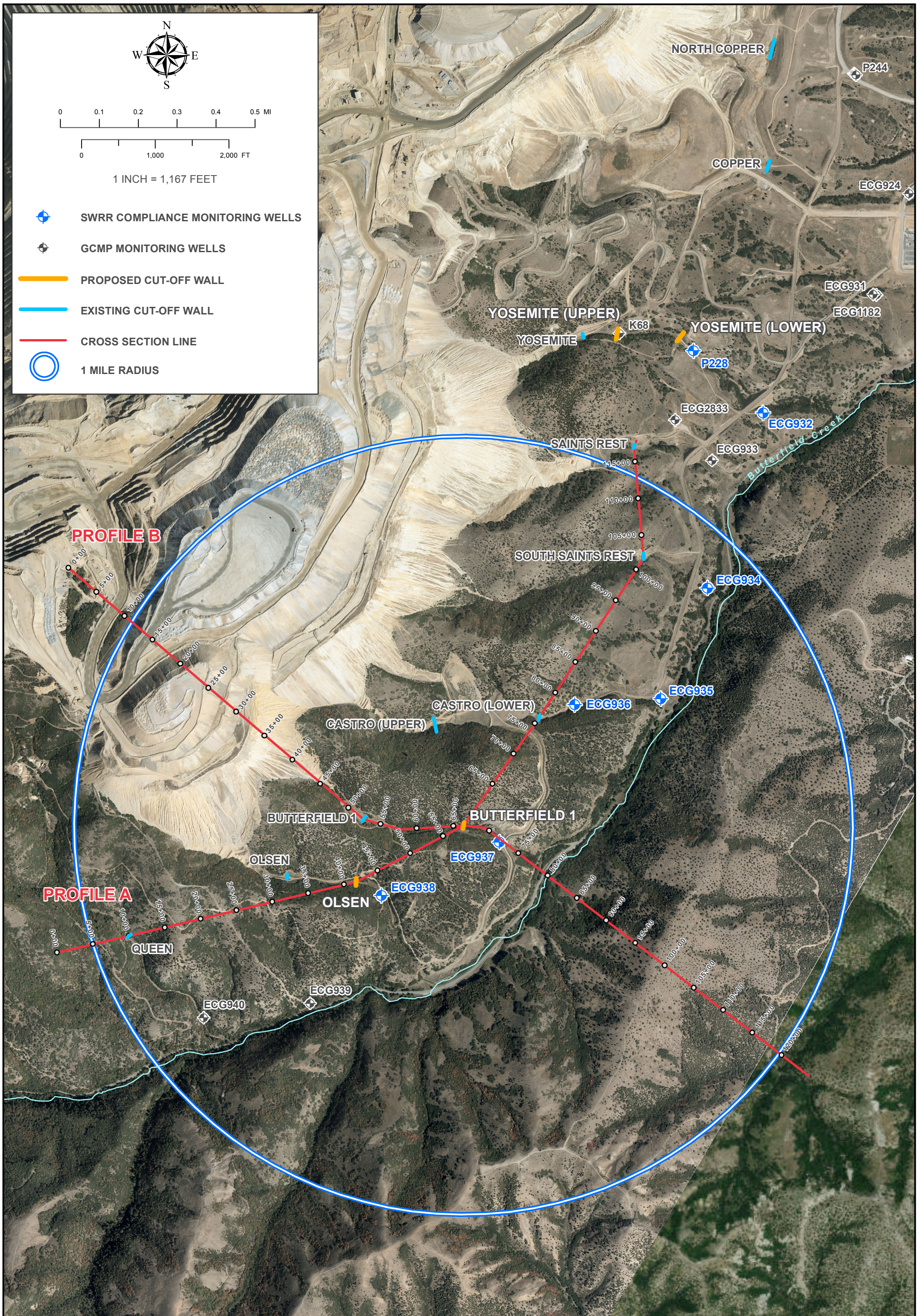

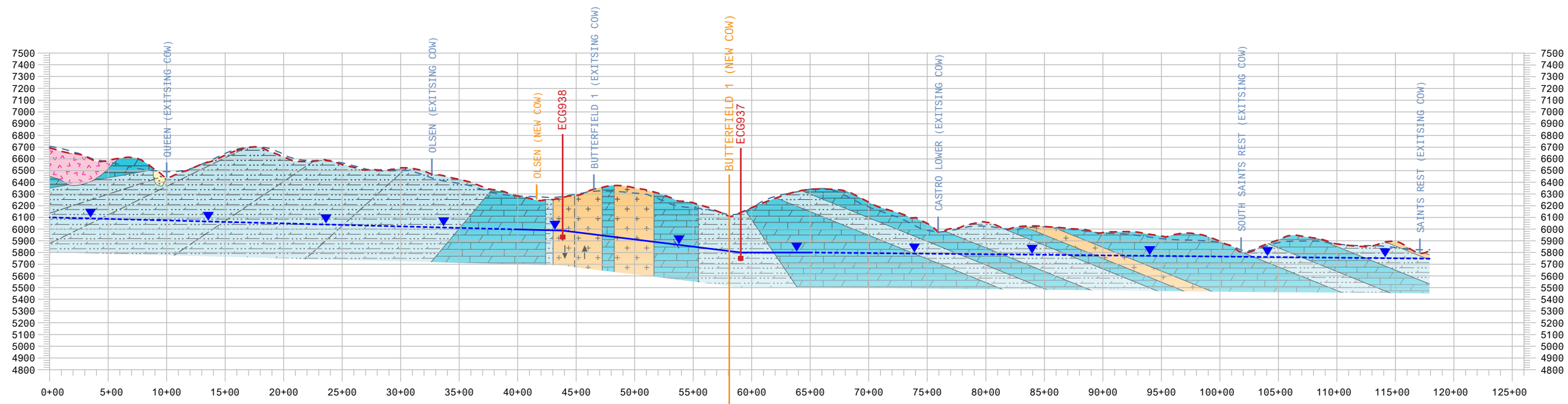

A PROFILE A
 HZ: 1" = 500', VT: 1"=500'
 LOOKING NORTHWEST

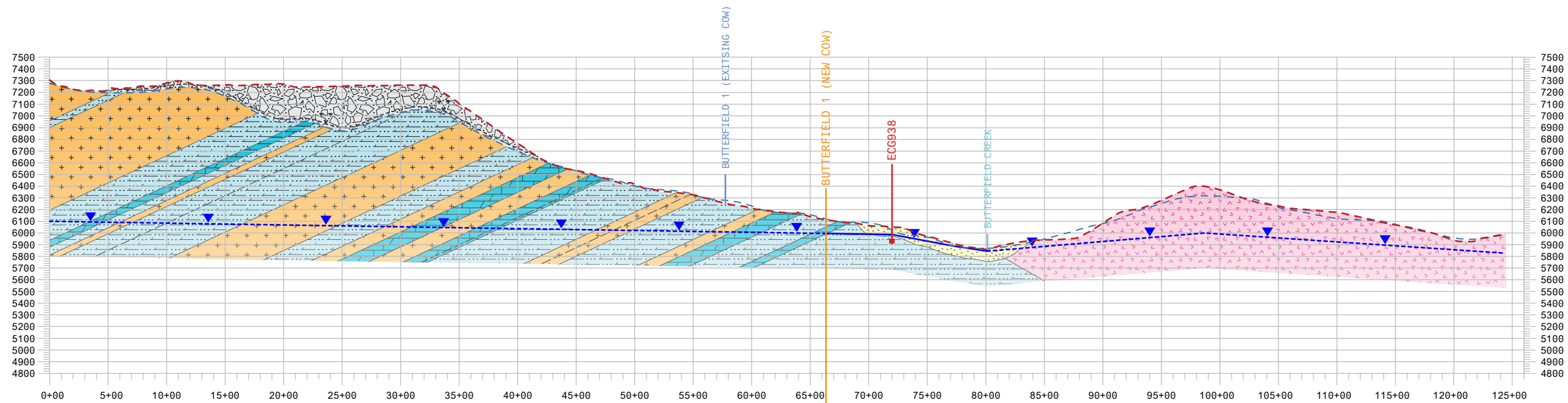
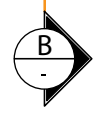

B PROFILE B
 HZ: 1" = 500', VT: 1"=500'
 LOOKING NORTHEAST

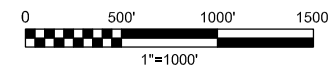
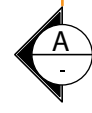

Drawing No. 6

RioTinto
 RIO TINTO KENNECOTT COPPER
**BUTTERFIELD 1 DRAINAGE AREA
 GEOLOGIC CROSS SECTIONS**
 SOUTH WASTE ROCK RECLAMATION PROJECT

MONITOR WELL LOC ID	SCREEN INTERVAL (ft bgs)	TOTAL DEPTH OF BORING (ft bgs)	ELEVATION OF GROUND SURFACE (ft amsl)	WATER SURFACE ELEVATION (ft amsl)
ECG938	242-282	295	6197	5984
ECG937	276-316	320	6043	5800

LEGEND

- WASTE ROCK DUMP
- TERTIARY VOLCANICS
LATITE BRECCIA WITH INTERBEDDED TUFF, SANDS AND GRAVELS
- TERTIARY INTRUSIVES
MONZONITE/QUARTZ MONZONITE AND LATITE PORPHYRY
- BUTTERFIELD PEAKS FORMATION
INTERBEDDED QUARTZITIC SANDSTONE & CALCARIOUS SANDSTONE WITH SEVERAL LIMESTONE INTERVALS
- BUTTERFIELD PEAKS FORMATION
INTERBEDDED LIMESTONE INTERVAL
- MONITORING WELL
- CURRENT TOPOGRAPHY
- PRE-DUMP TOPOGRAPHY
- FAULT
- BEDROCK GROUNDWATER TABLE (DASHED WHERE INFERRED)
- SATURATED ZONE IN WASTE ROCK (DASHED WHERE INFERRED)

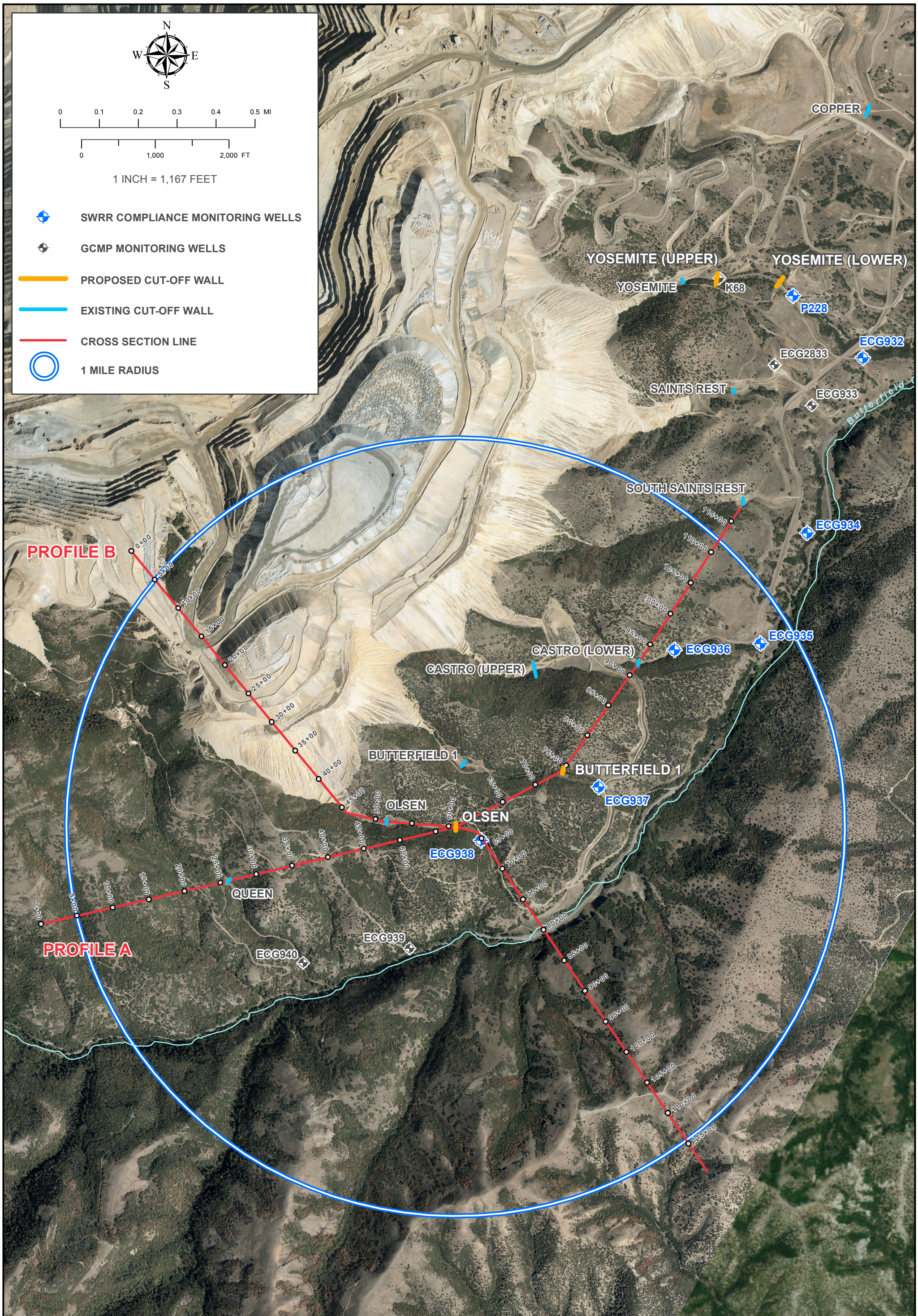

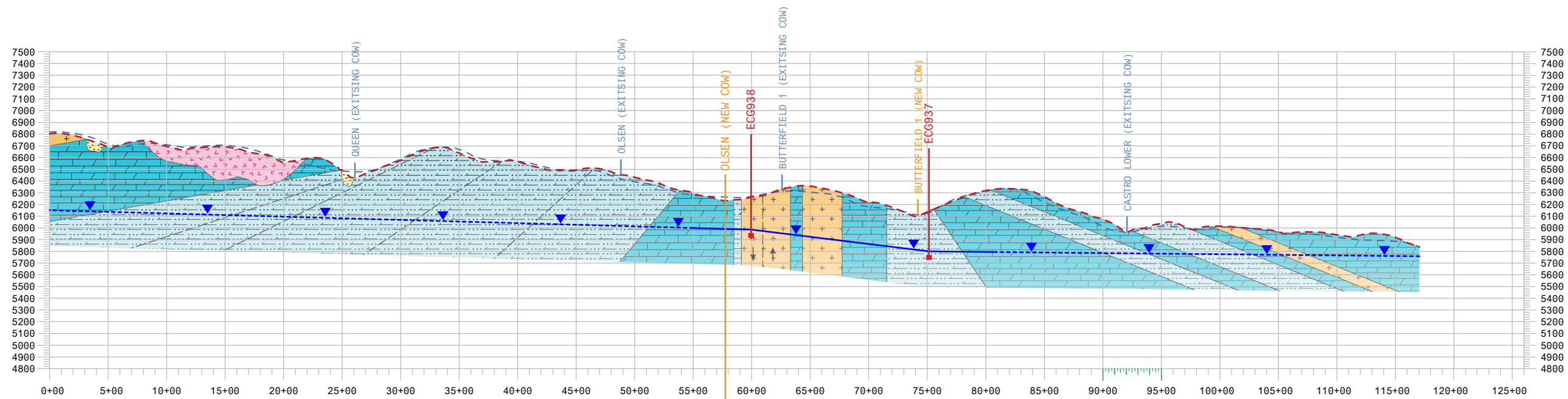

A PROFILE A
 HZ: 1" = 500', VT: 1" = 500'
 LOOKING NORTHWEST

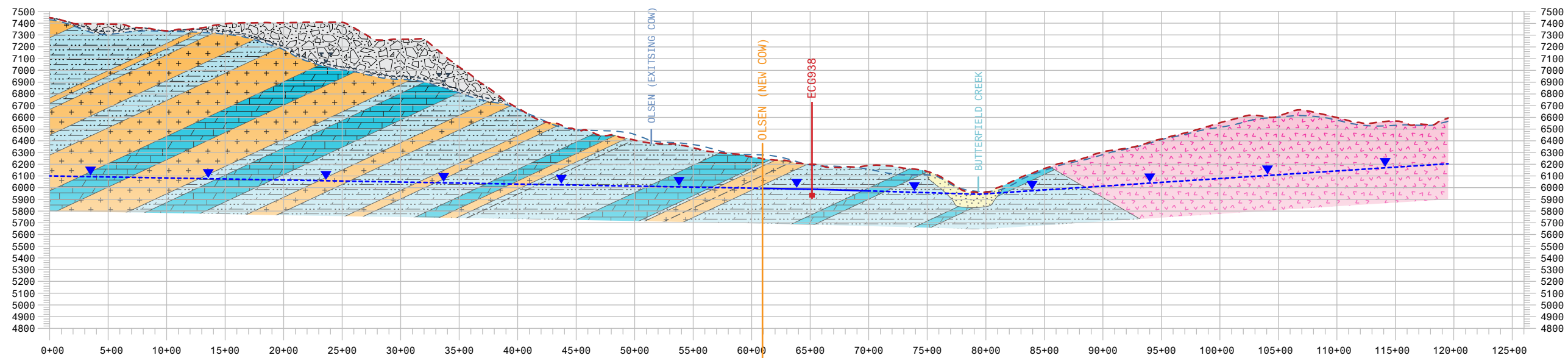

B PROFILE B
 HZ: 1" = 500', VT: 1" = 500'
 LOOKING NORTHEAST

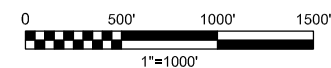

Drawing No. 8

RIO TINTO KENNECOTT COPPER
**OLSEN DRAINAGE AREA
 GEOLOGIC CROSS SECTIONS**
 SOUTH WASTE ROCK RECLAMATION PROJECT



MONITOR WELL LOC ID	SCREEN INTERVAL (ft bgs)	TOTAL DEPTH OF BORING (ft bgs)	ELEVATION OF GROUND SURFACE (ft amsl)	WATER SURFACE ELEVATION (ft amsl)
ECG938	242-282	295	6197	5984
ECG937	276-316	320	6043	5800

LEGEND

- WASTE ROCK DUMP
- TERTIARY VOLCANICS
LATITE BRECCIA WITH INTERBEDDED TUFF, SANDS AND GRAVELS
- TERTIARY INTRUSIVES
MONZONITE/QUARTZ MONZONITE AND LATITE PORPHYRY
- BUTTERFIELD PEAKS FORMATION
INTERBEDDED QUARTZITIC SANDSTONE & CALCARIOUS SANDSTONE WITH SEVERAL LIMESTONE INTERVALS
- BUTTERFIELD PEAKS FORMATION
INTERBEDDED LIMESTONE INTERVAL
- MONITORING WELL
- CURRENT TOPOGRAPHY
- PRE-DUMP TOPOGRAPHY
- FAULT
- BEDROCK GROUNDWATER TABLE (DASHED WHERE INFERRED)
- SATURATED ZONE IN WASTE ROCK (DASHED WHERE INFERRED)

APPENDIX A
**Time Series Plots for Monitoring Wells
in the Vicinity of SWRR**

TDS ECG924

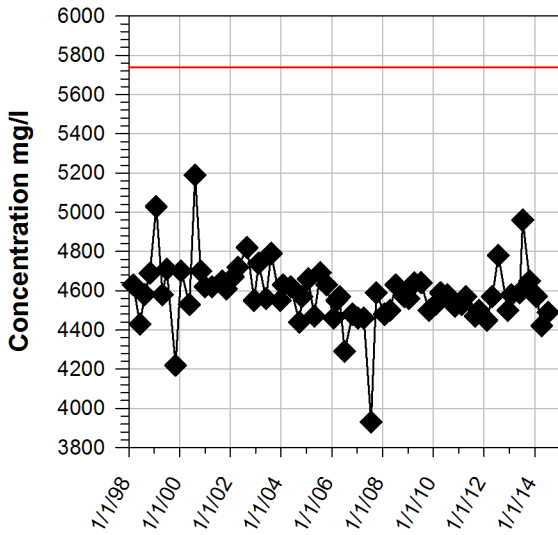

Cu ECG924

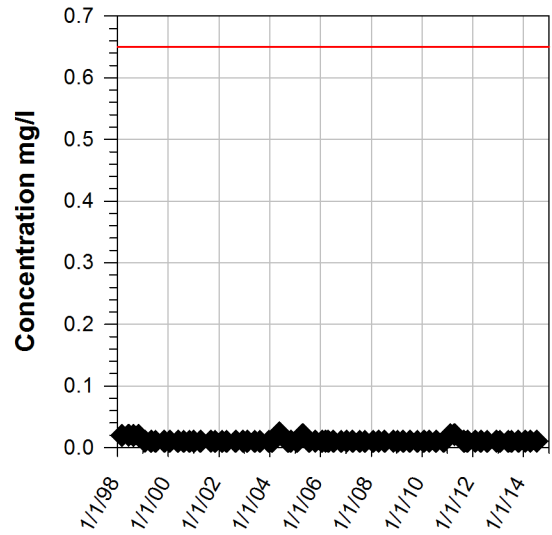

SO4 ECG924

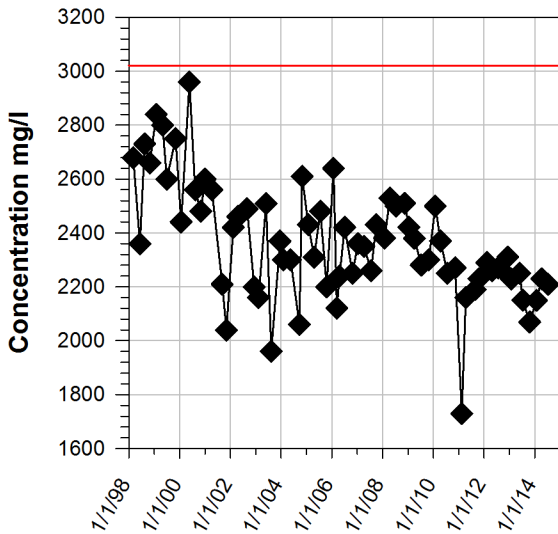

Cd ECG924

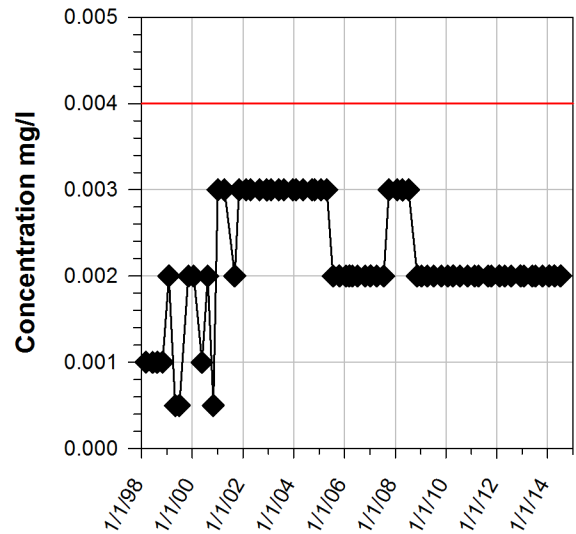

pH ECG924

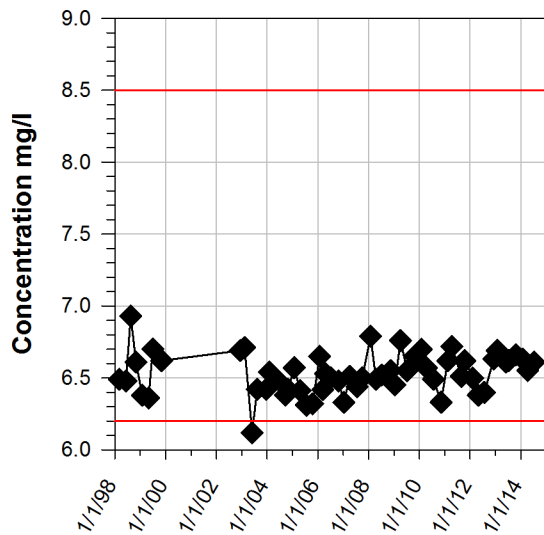

Zn ECG924

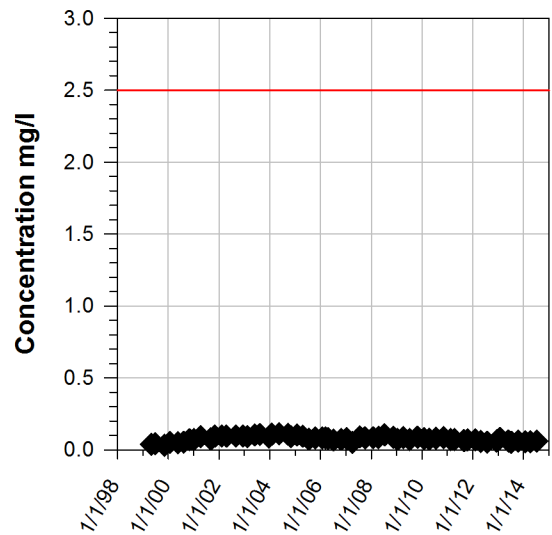

TDS ECG925

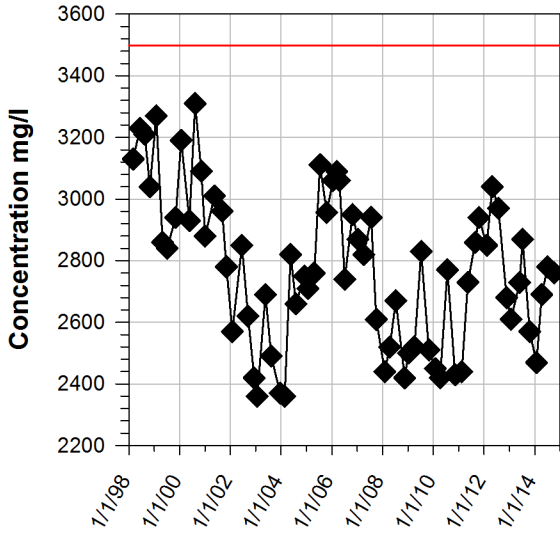

Cu ECG925

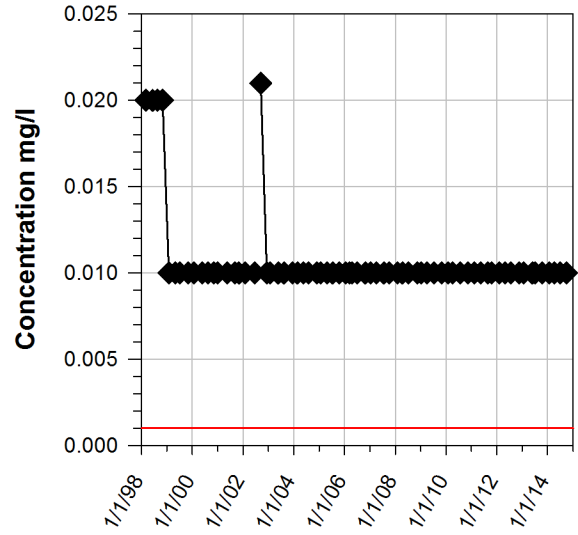

SO4 ECG925

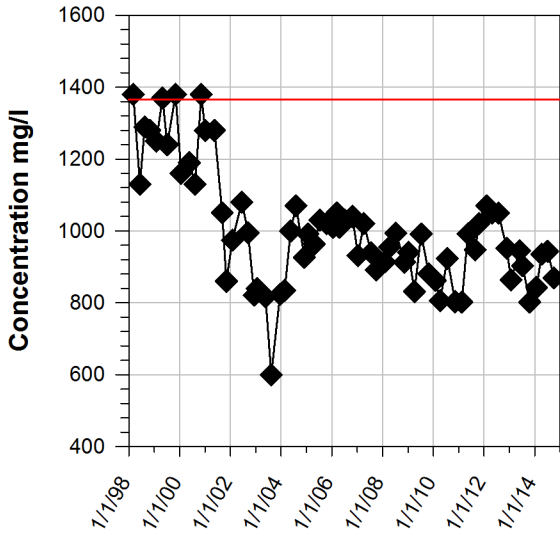

Cd ECG925

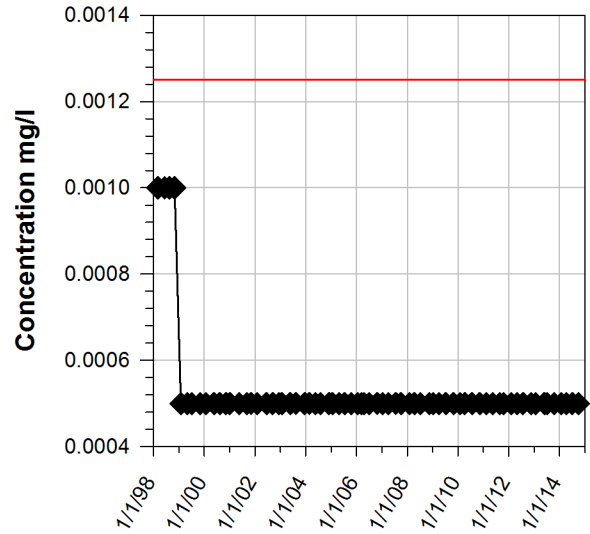

pH ECG925

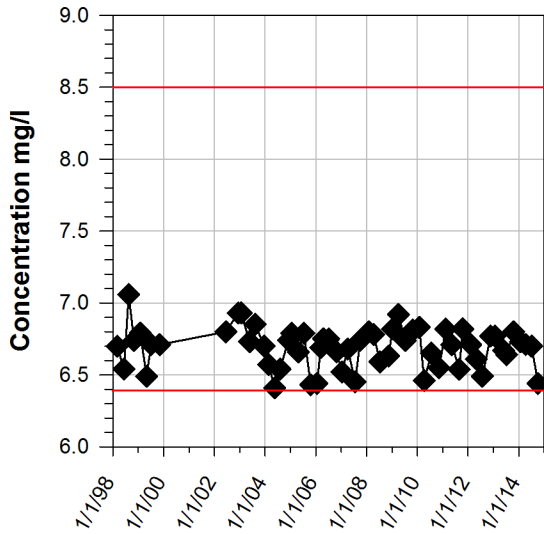

Zn ECG925

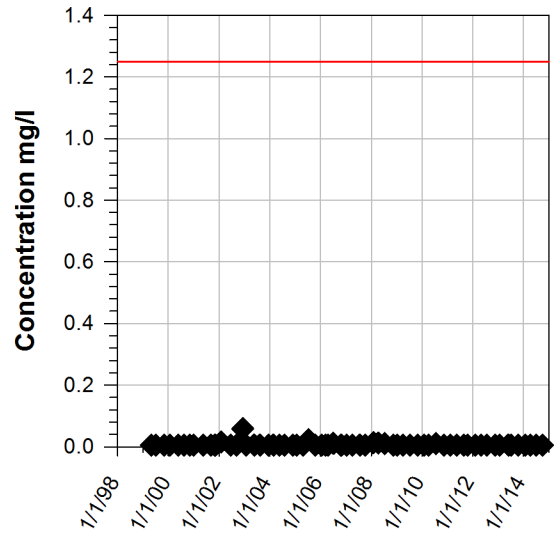

TDS ECG931

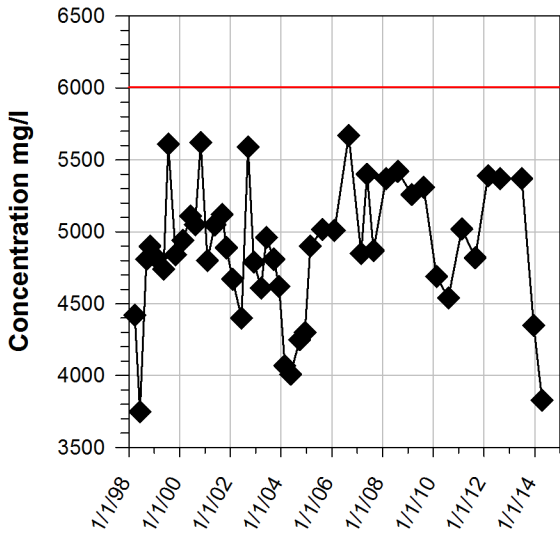

Cu ECG931

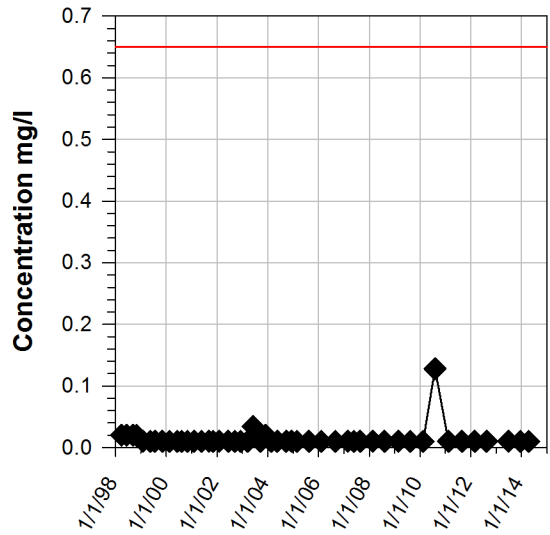

SO4 ECG931

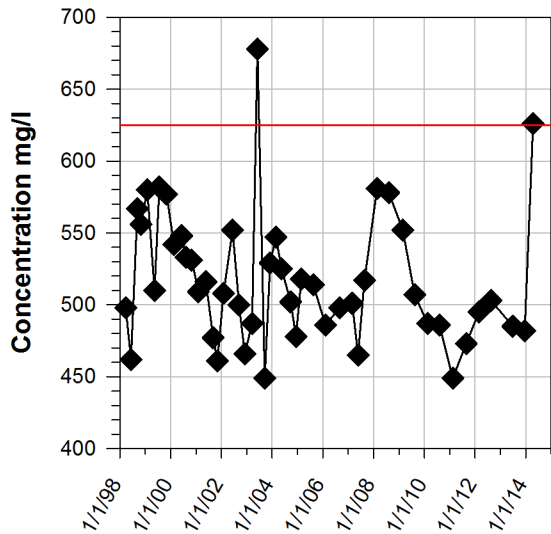

Cd ECG931

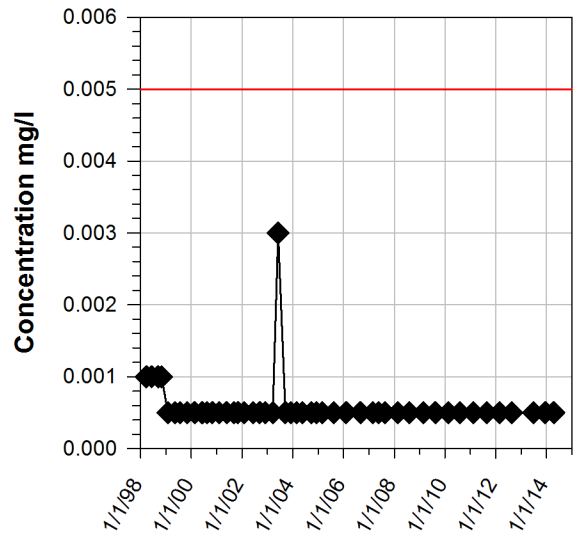

pH ECG931

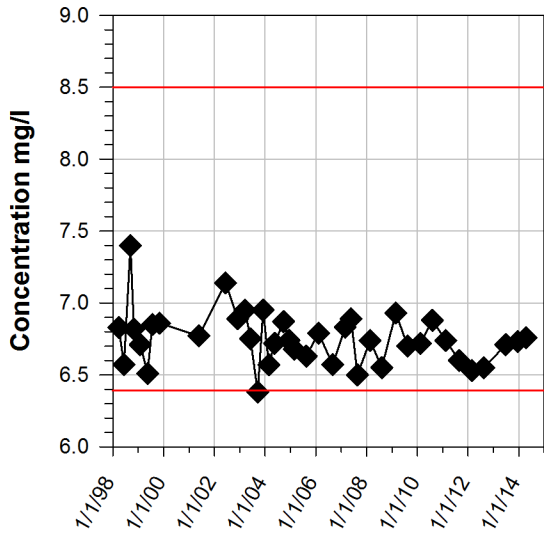

Zn ECG931

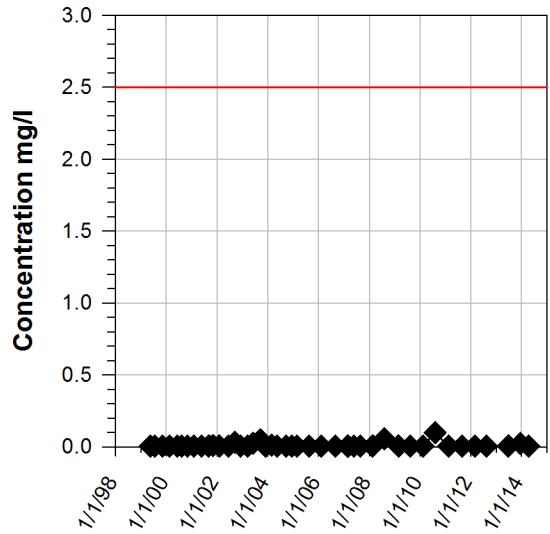

TDS ECG932

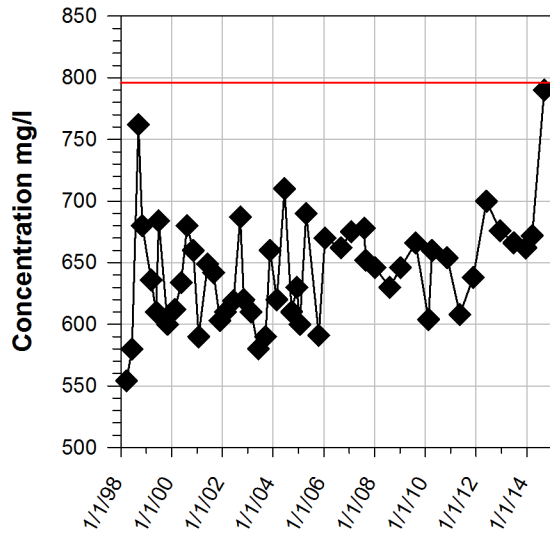

Cu ECG932

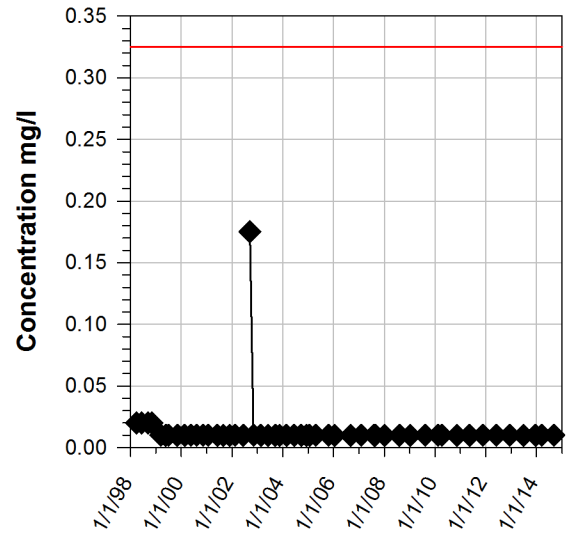

SO4 ECG932

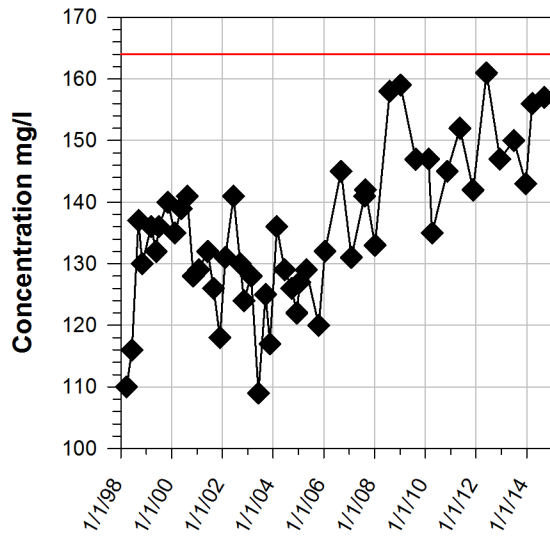

Cd ECG932

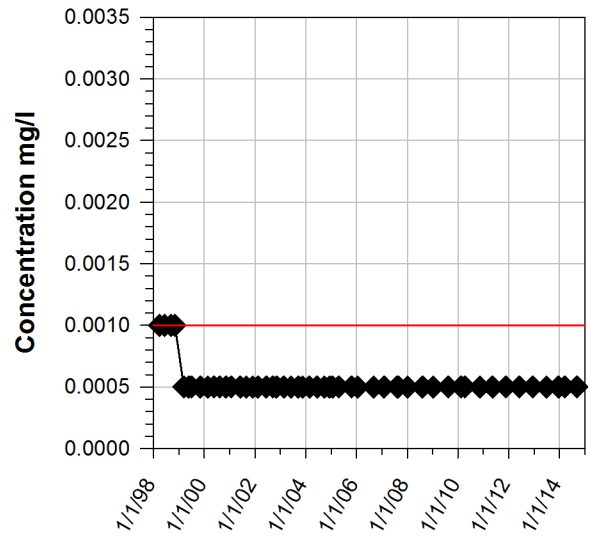

pH ECG932

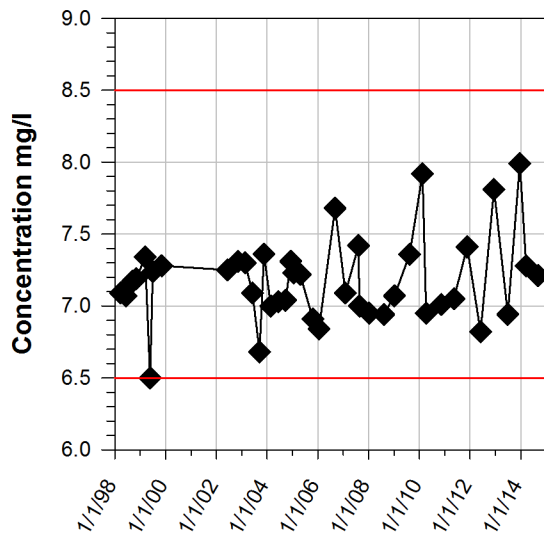

Zn ECG932

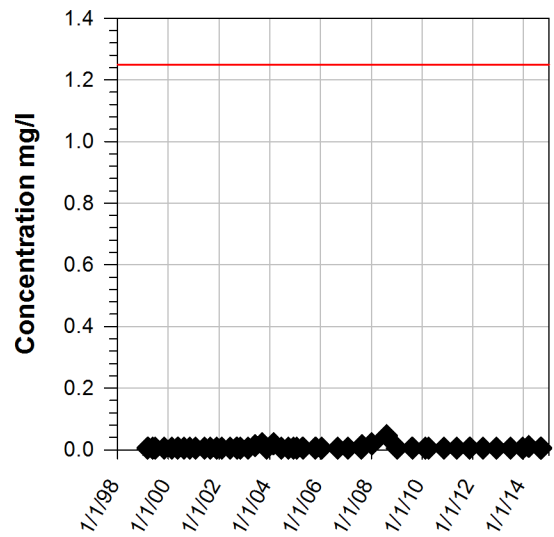

TDS ECG933

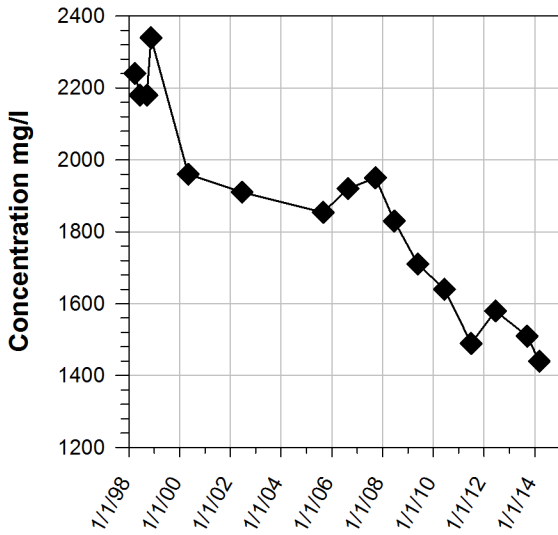

Cu ECG933

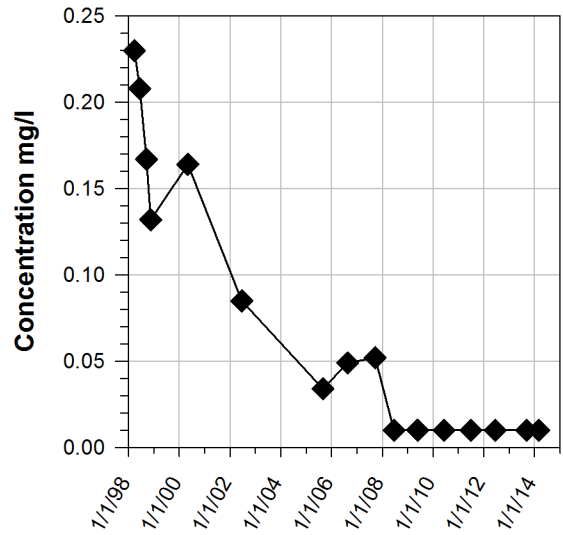

SO4 ECG933

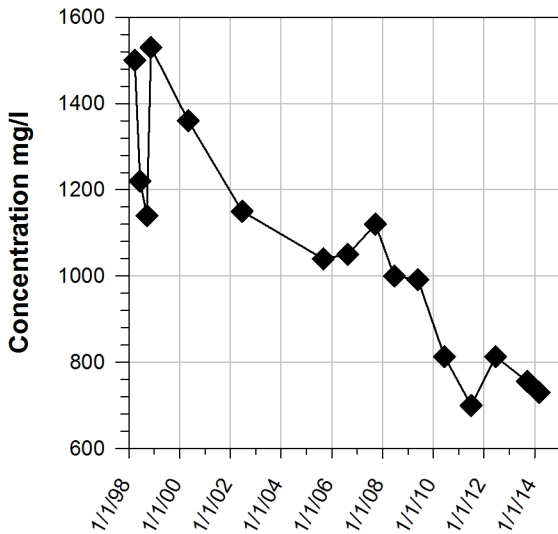

Cd ECG933

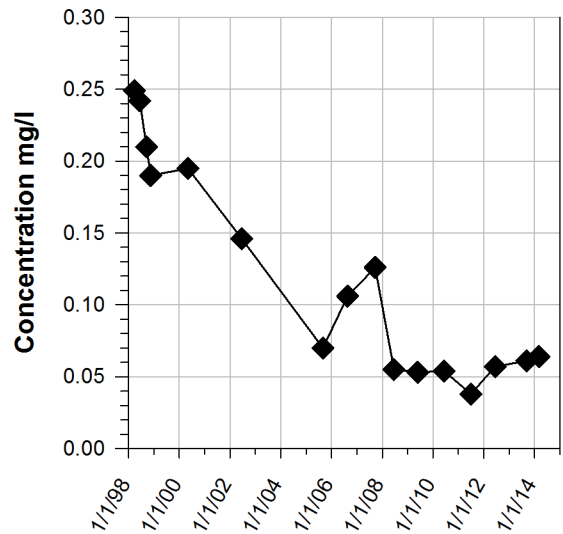

pH ECG933

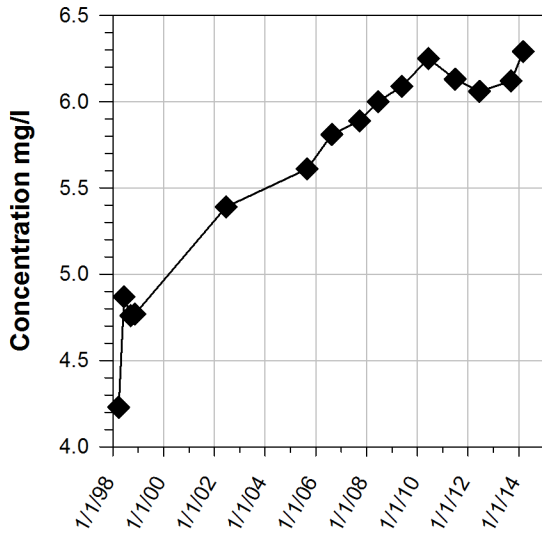

Zn ECG933

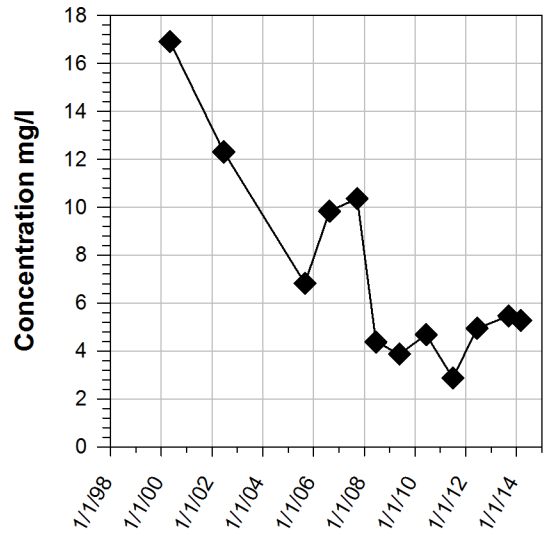

TDS ECG934

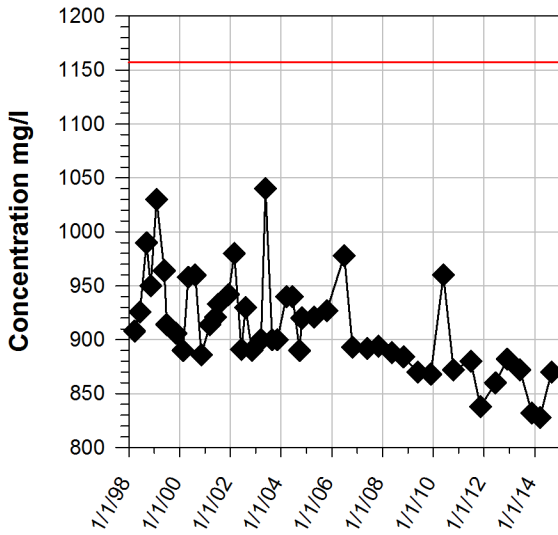

Cu ECG934

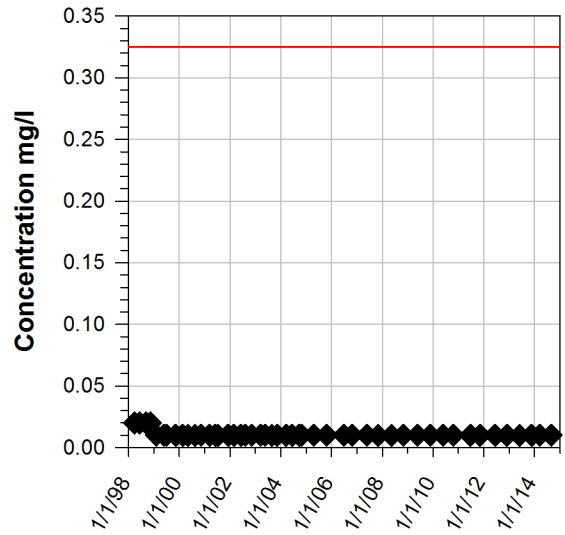

SO4 ECG934

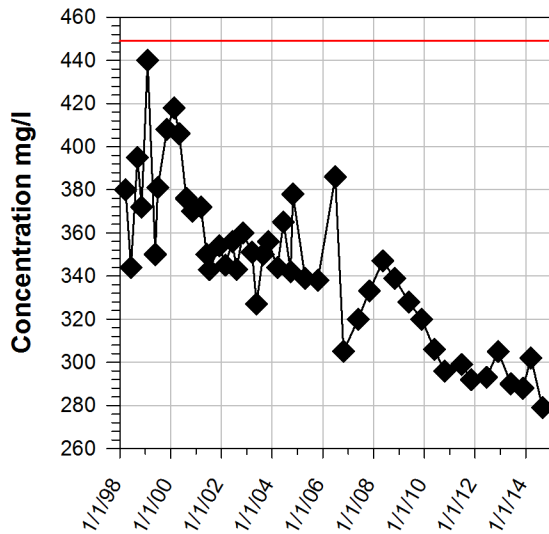

Cd ECG934

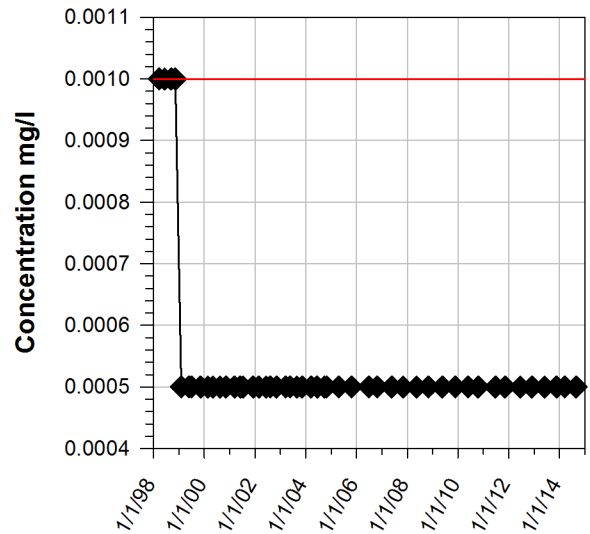

pH ECG934

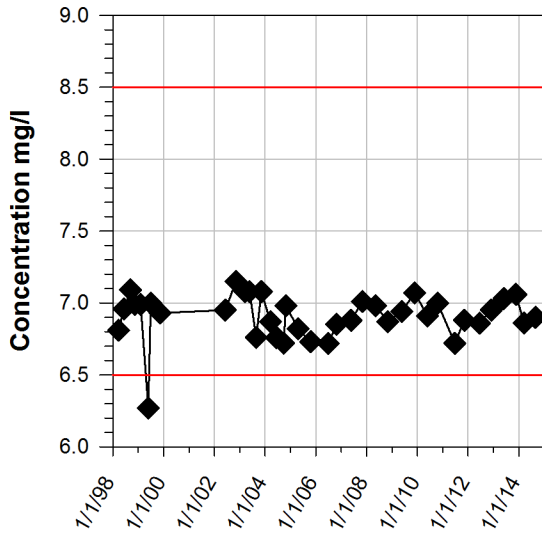

Zn ECG934

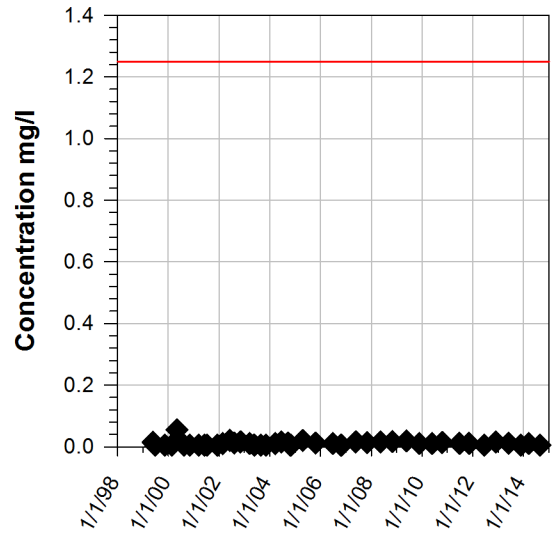

TDS ECG935

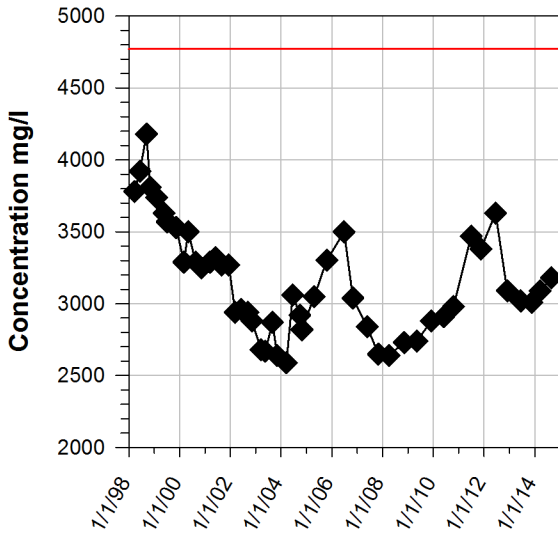

Cu ECG935

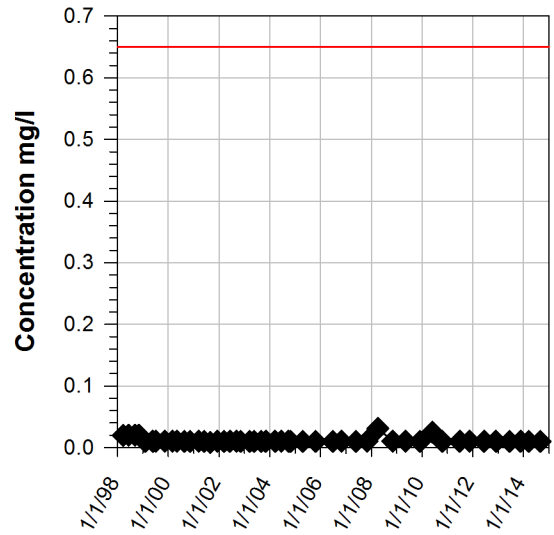

SO4 ECG935

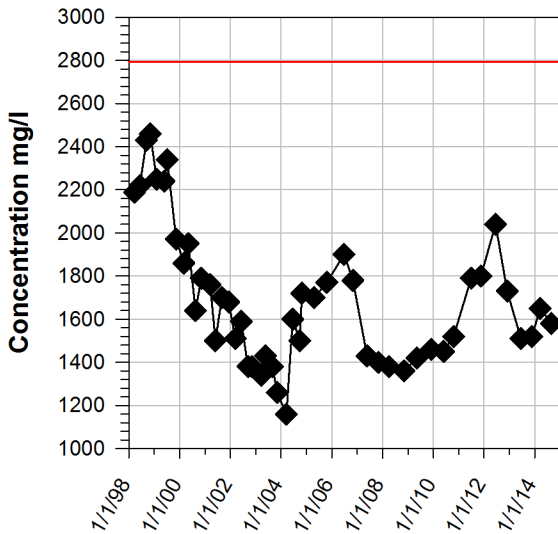

Cd ECG935

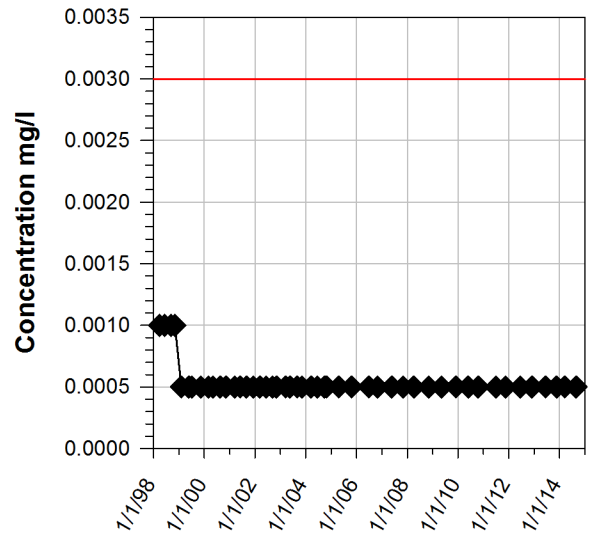

pH ECG935

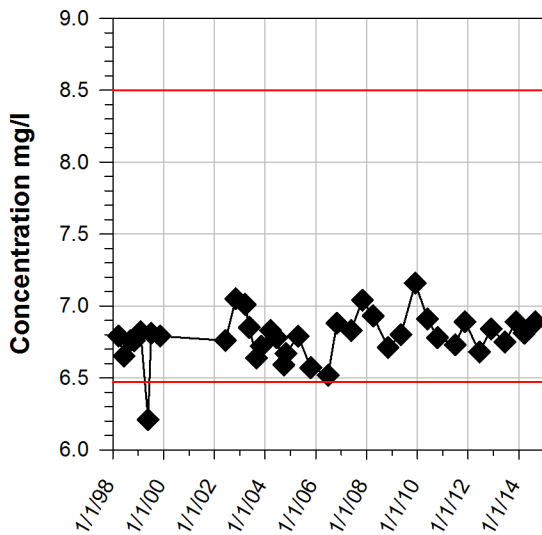

Zn ECG935

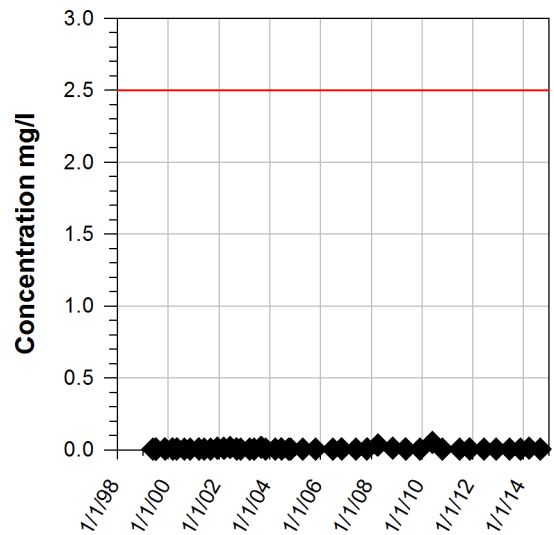

TDS ECG936

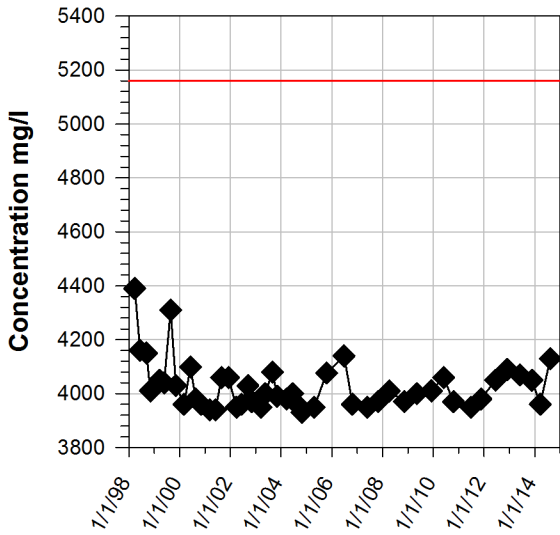

Cu ECG936

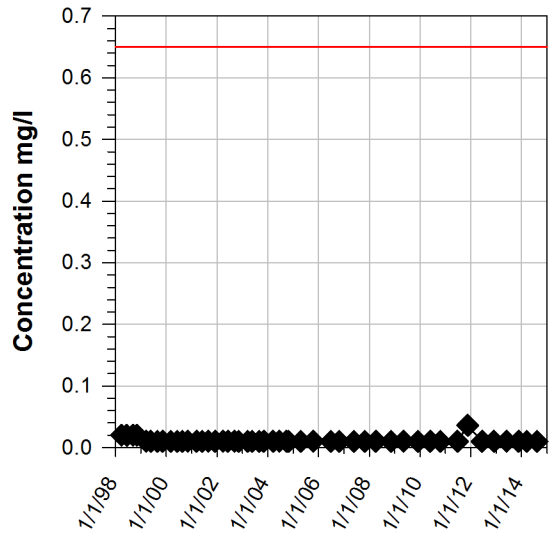

SO4 ECG936

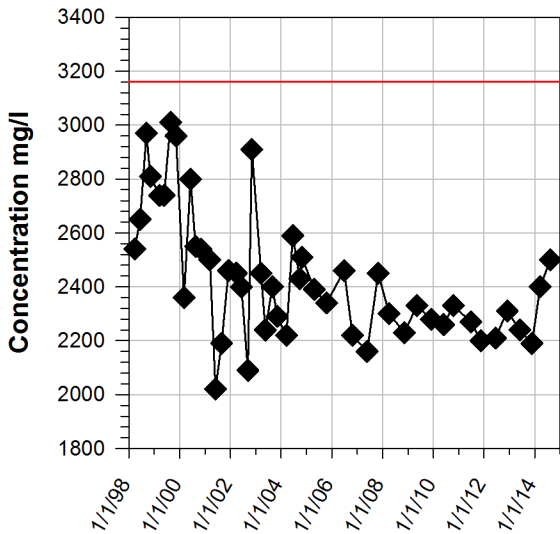

Cd ECG936

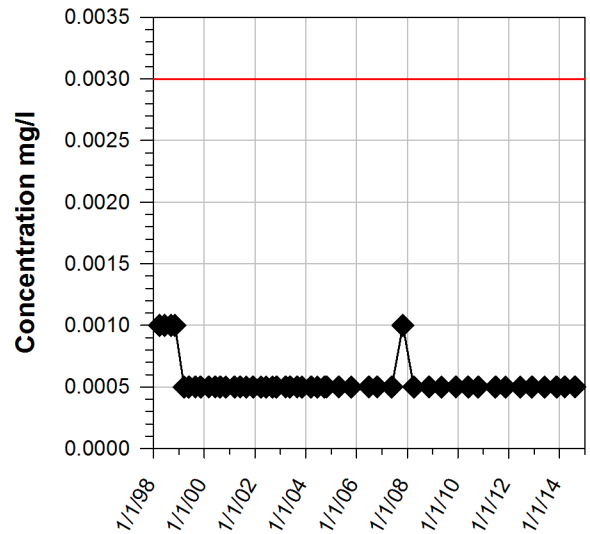

pH ECG936

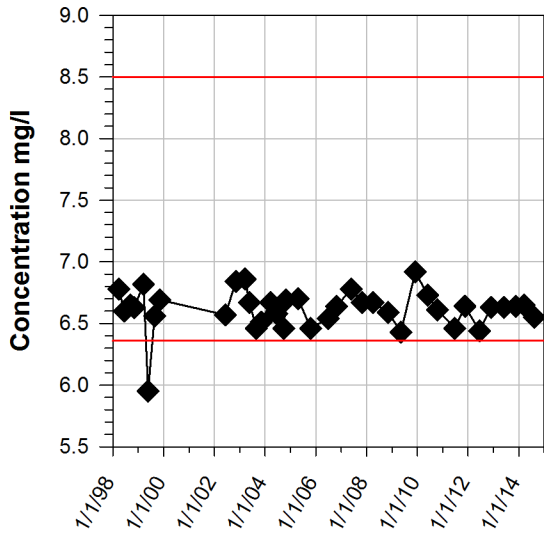

Zn ECG936

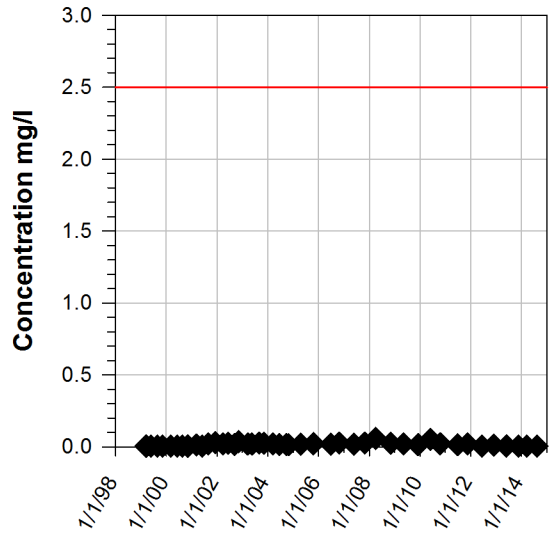

TDS ECG937

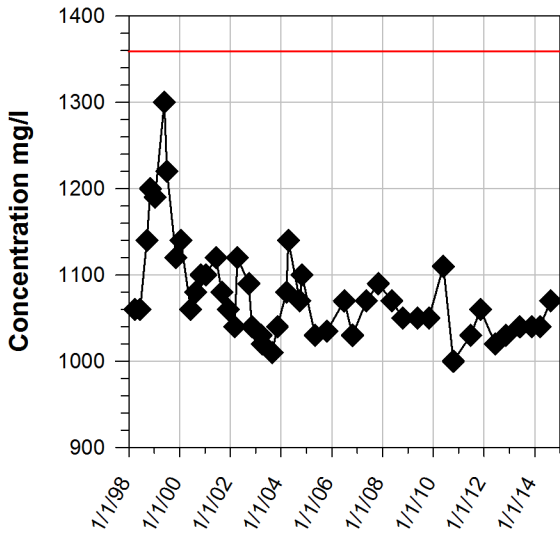

Cu ECG937

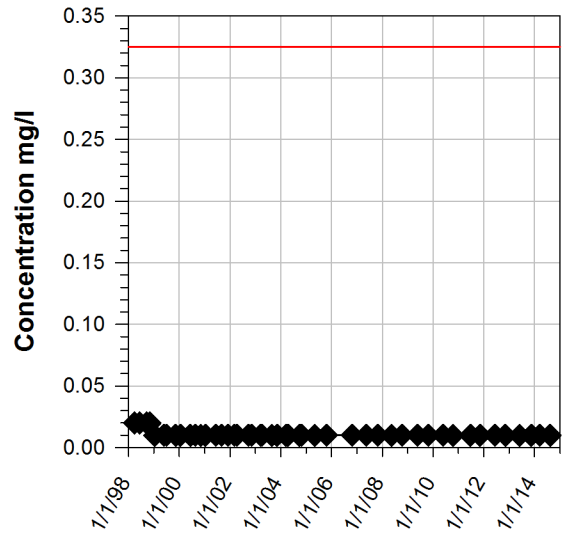

SO4 ECG937

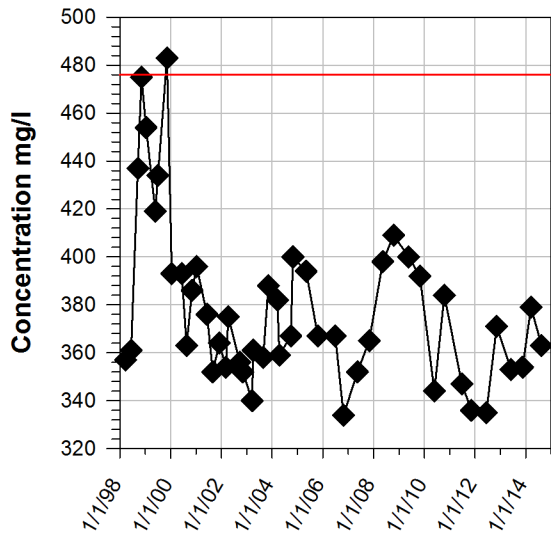

Cd ECG937

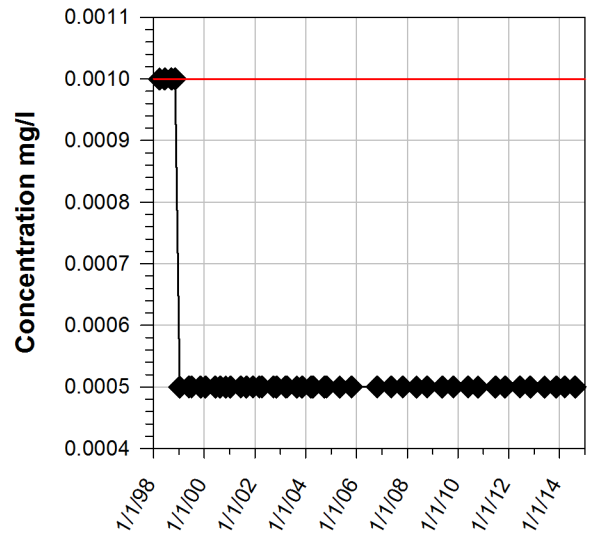

pH ECG937

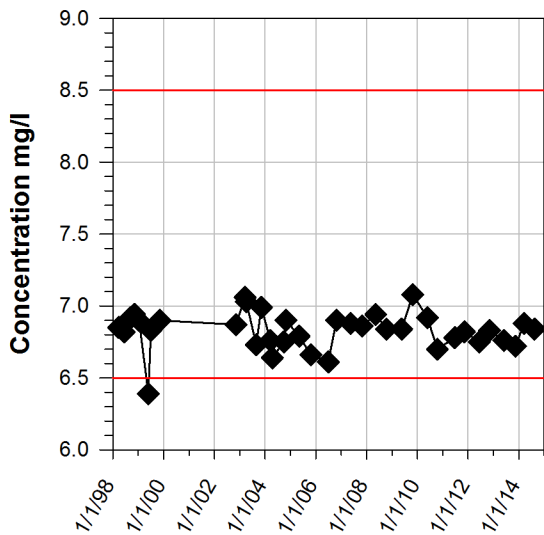

Zn ECG937

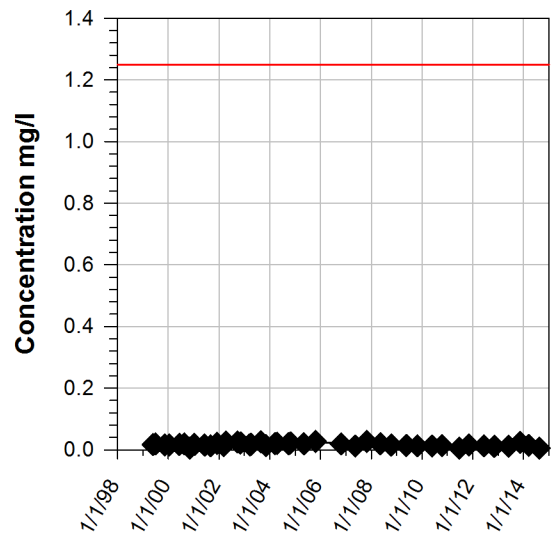

TDS ECG938

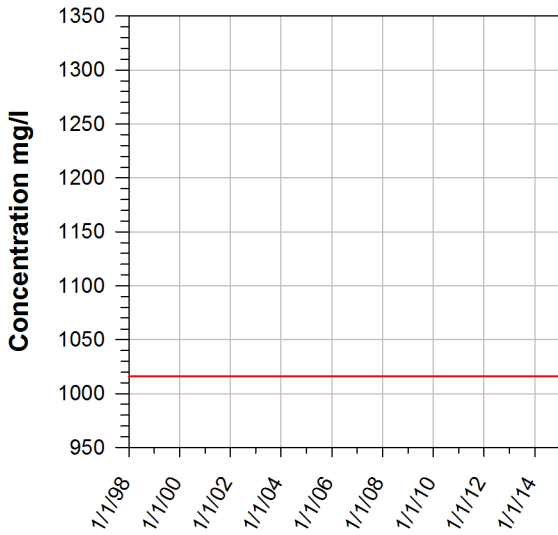

Cu ECG938

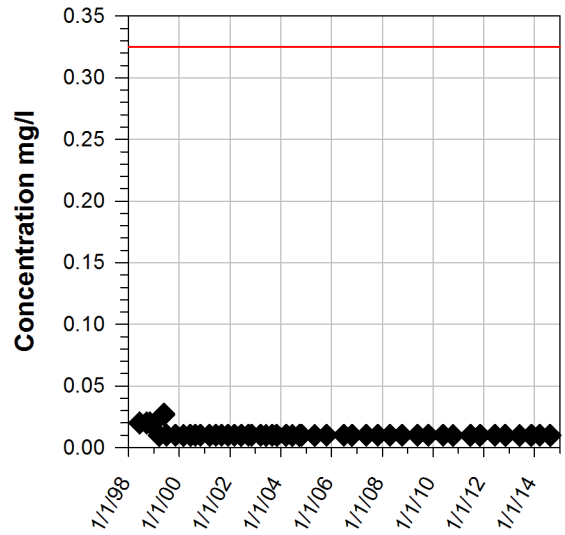

SO4 ECG938

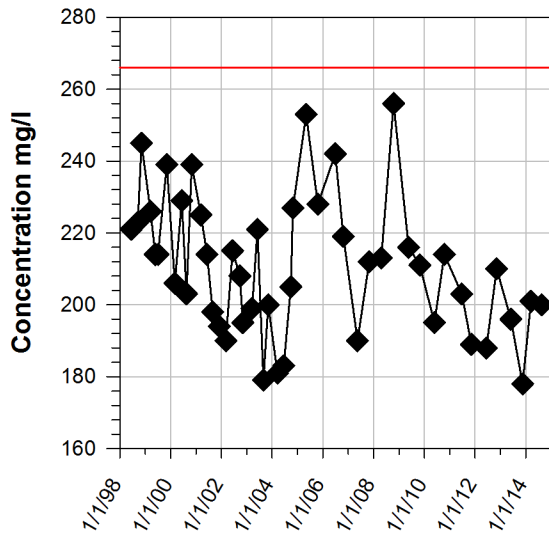

Cd ECG938

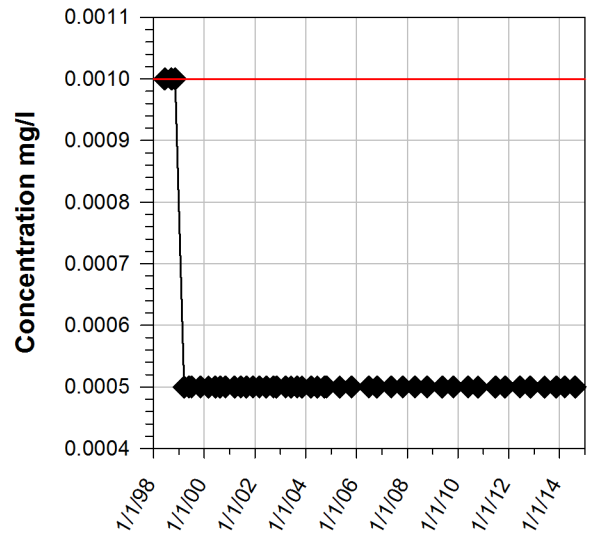

pH ECG938

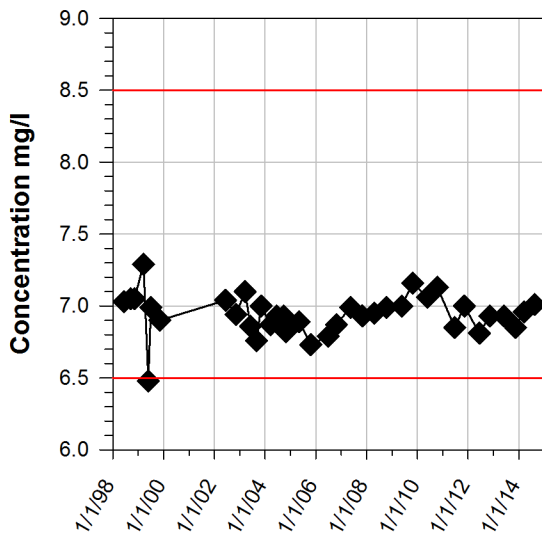

Zn ECG938

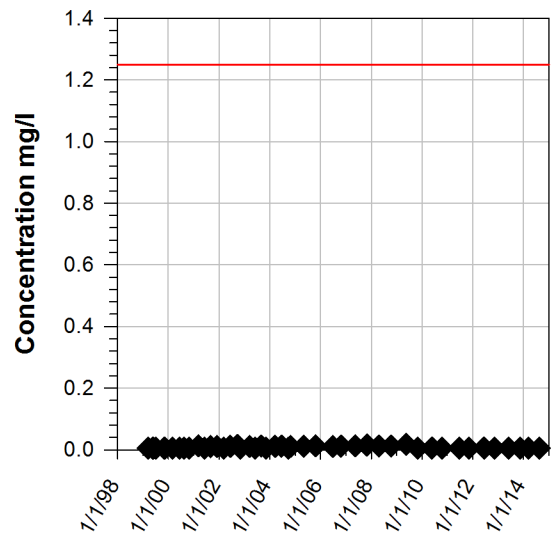

TDS ECG939

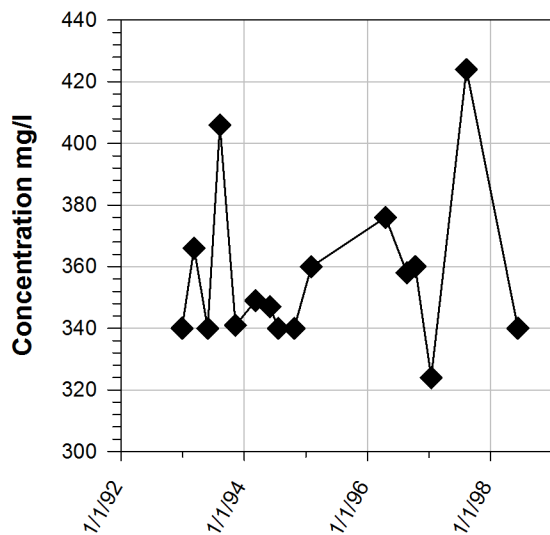

Cu ECG939

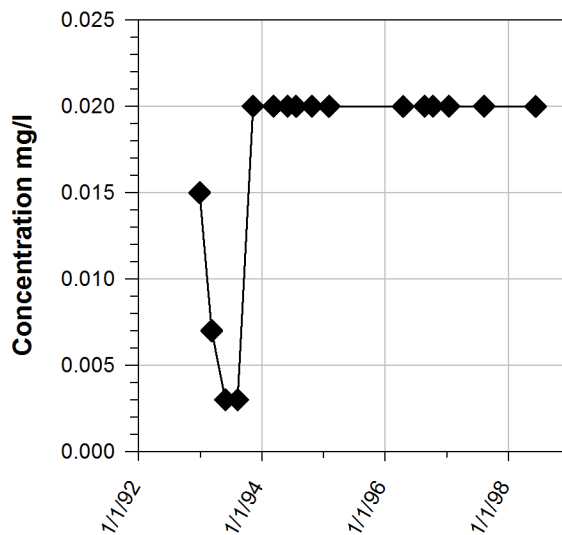

SO4 ECG939

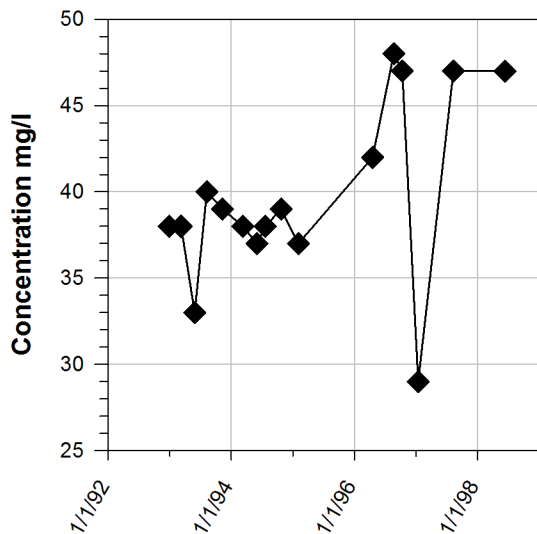

Cd ECG939

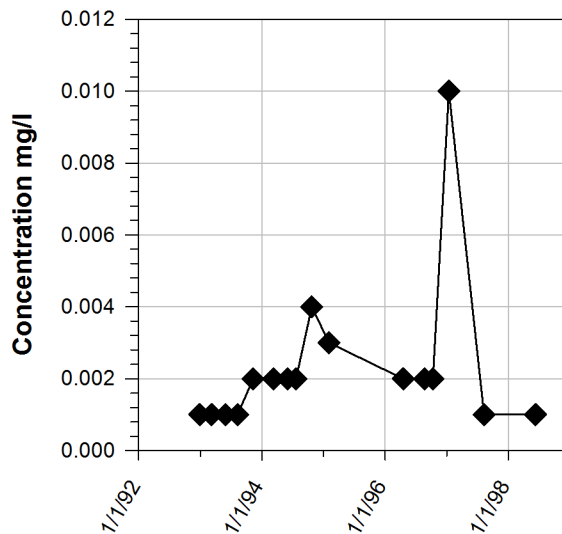

pH ECG939

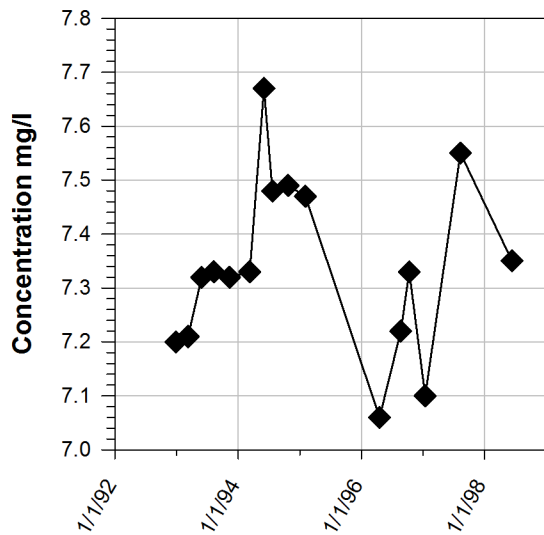

Zn ECG939

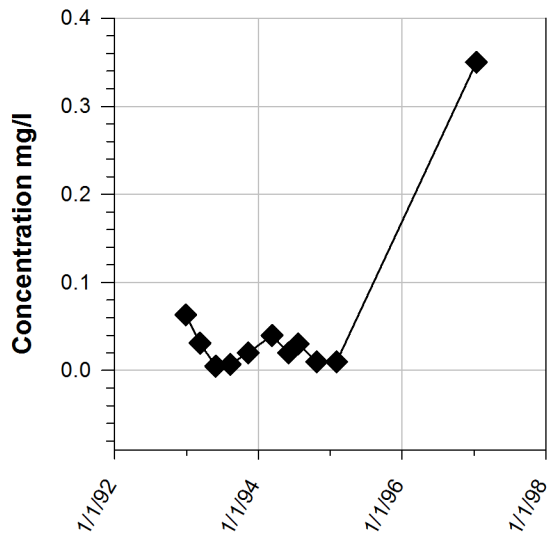

TDS ECG940

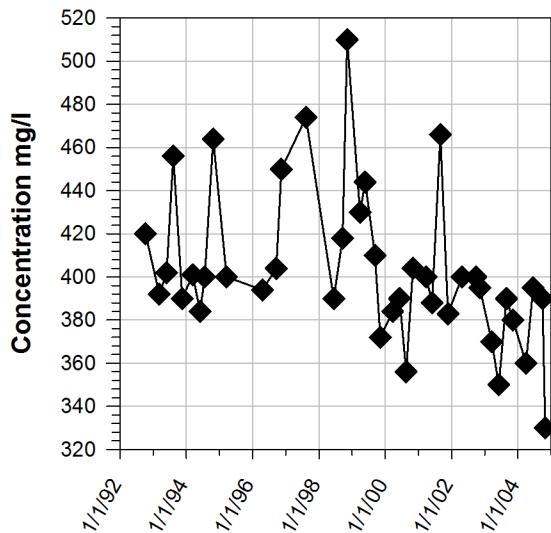

Cu ECG940

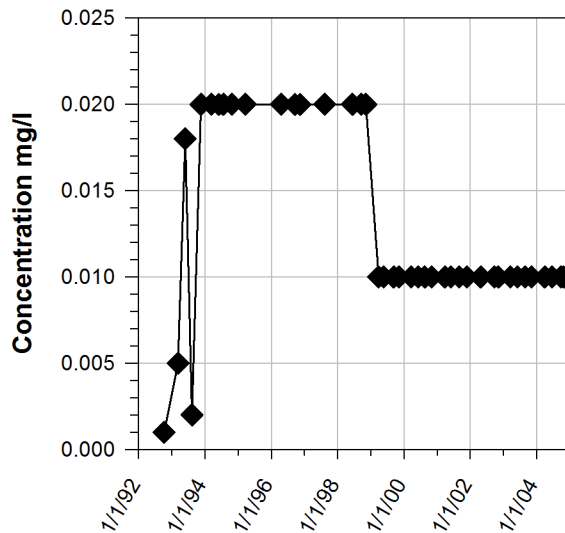

SO4 ECG940

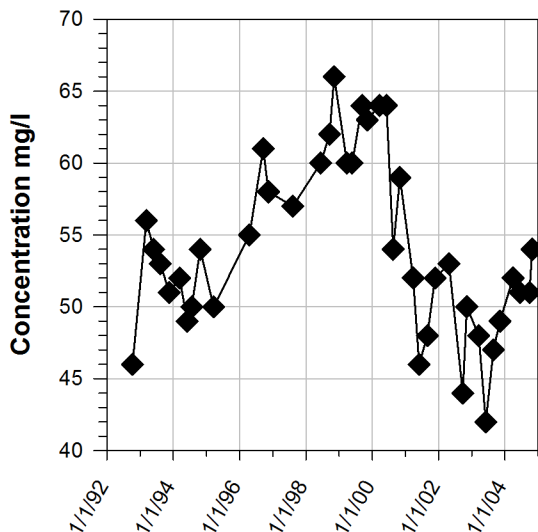

Cd ECG940

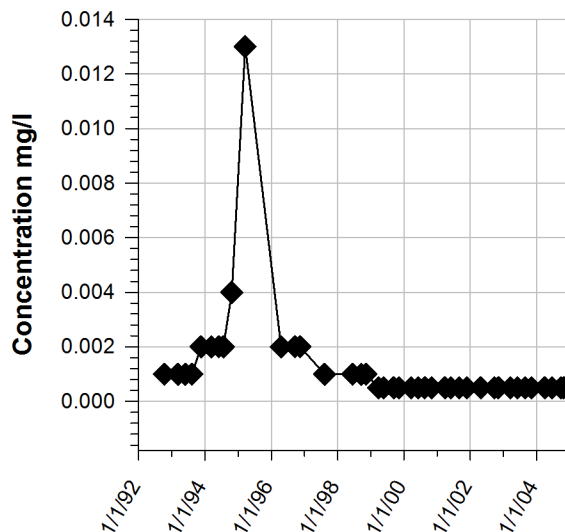

pH ECG940

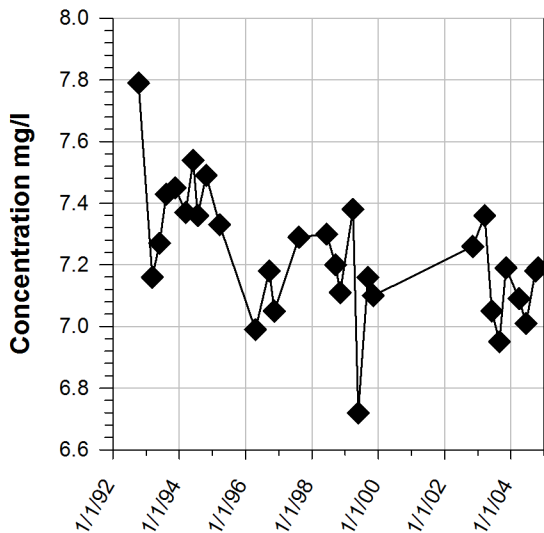

Zn ECG940

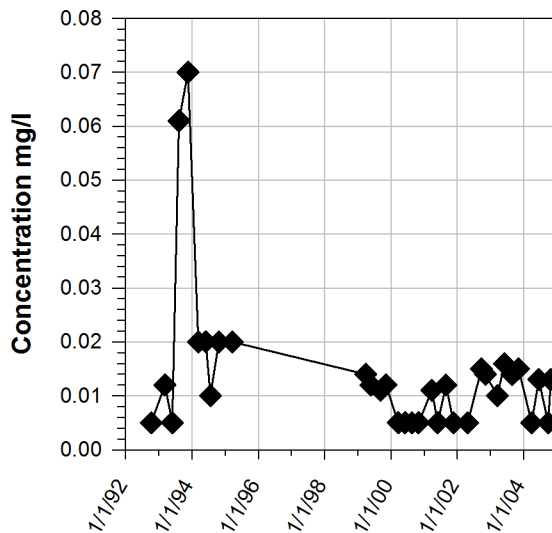

TDS ECG1182A

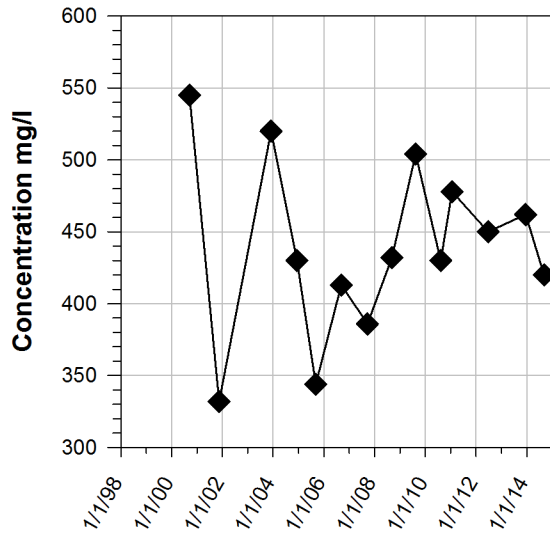

Cu ECG1182A

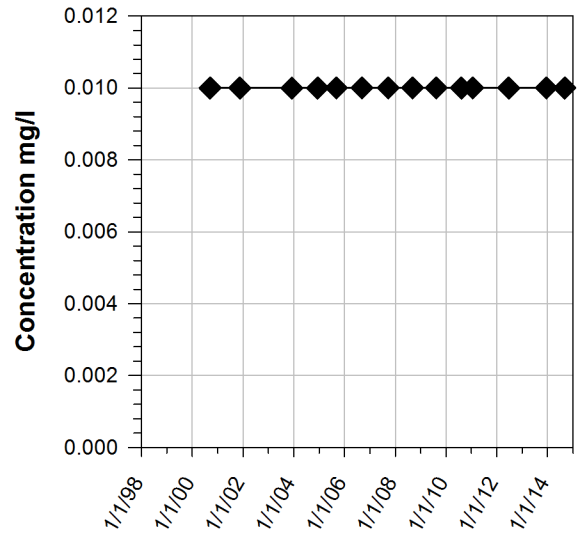

SO4 ECG1182A

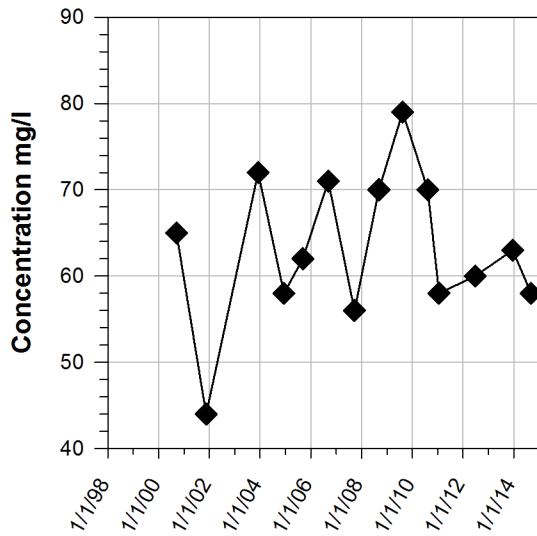

Cd ECG1182A

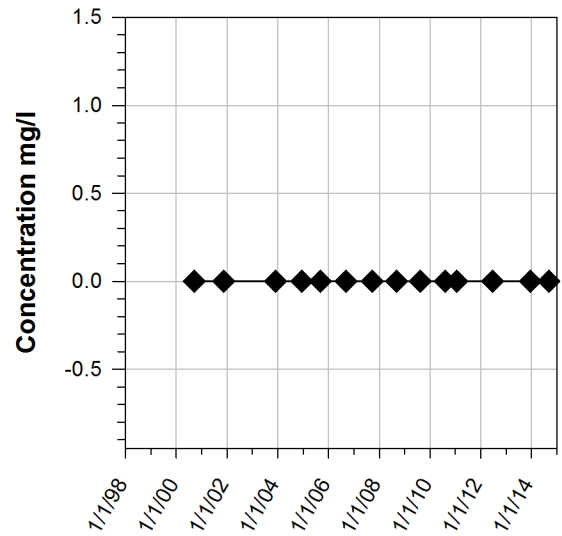

pH ECG1182A

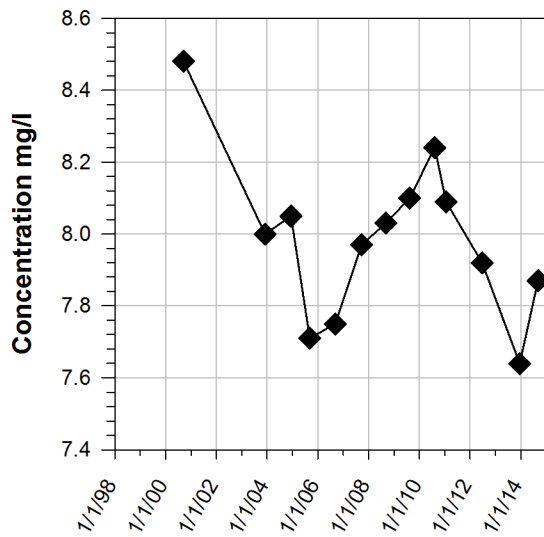

Zn ECG1182A

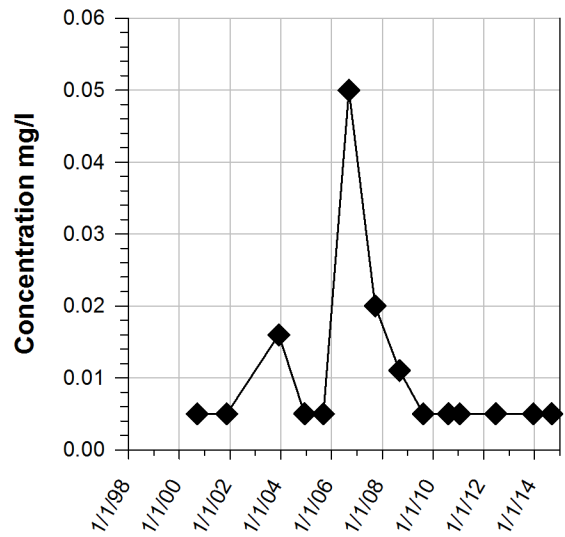

TDS ECG1183A

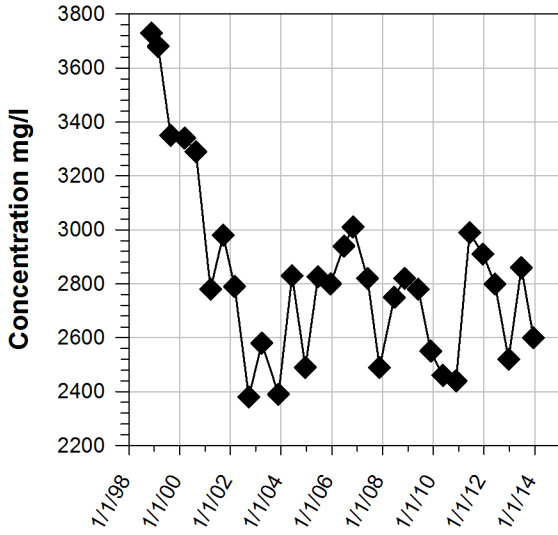

Cu ECG1183A

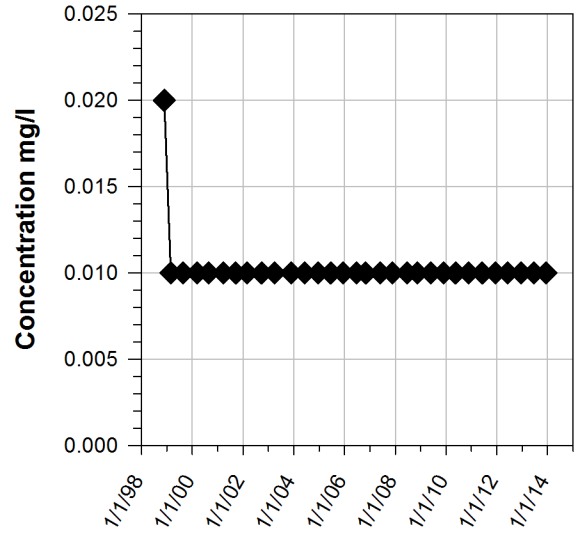

SO4 ECG1183A

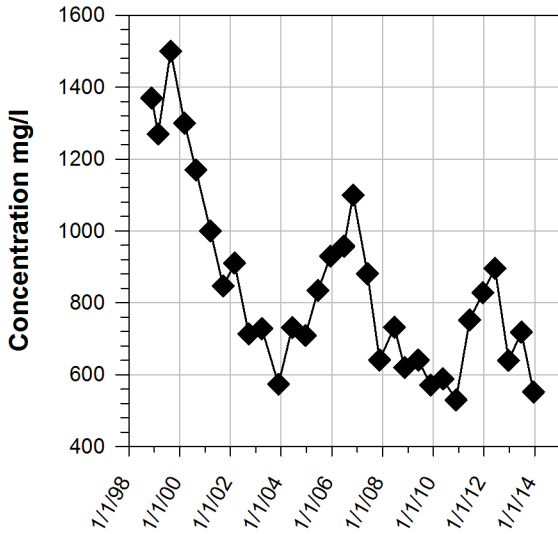

Cd ECG1183A

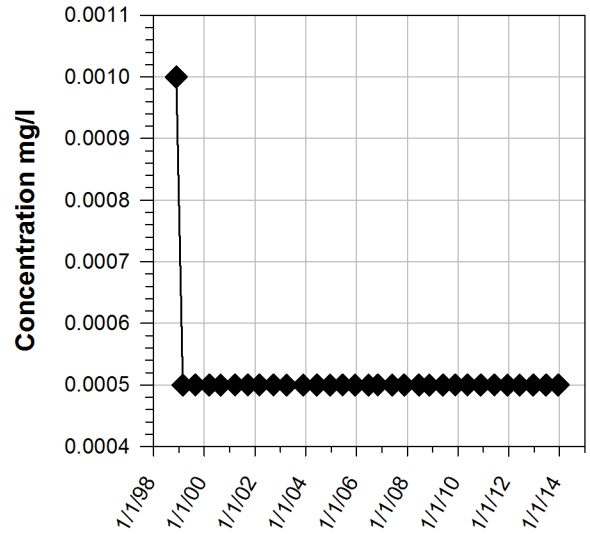

pH ECG1183A

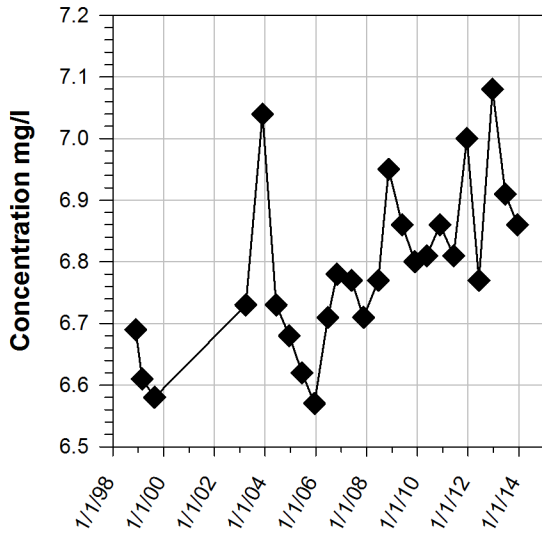

Zn ECG1183A

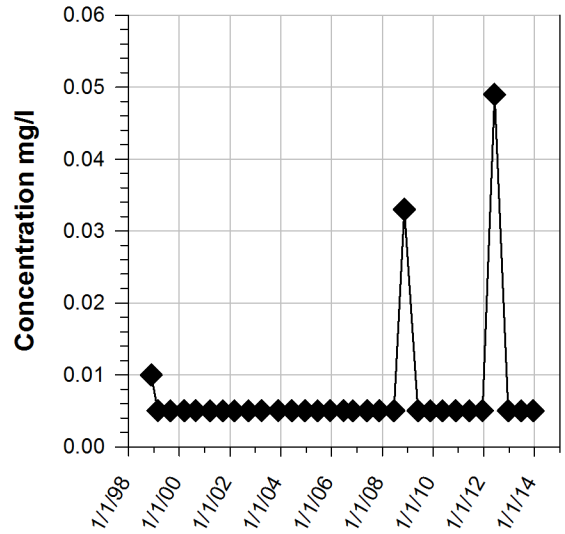

TDS ECG1184

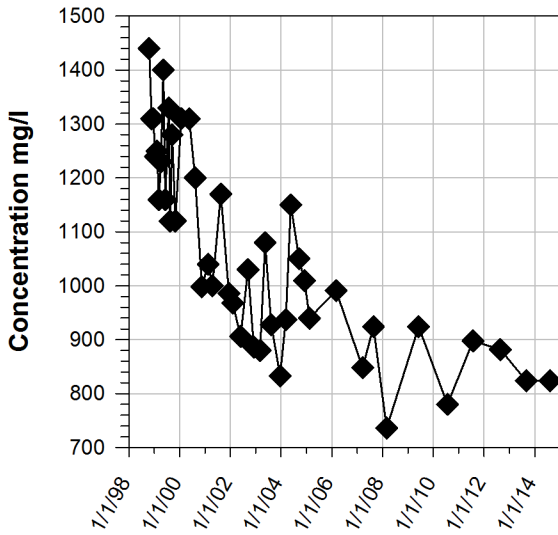

Cu ECG1184

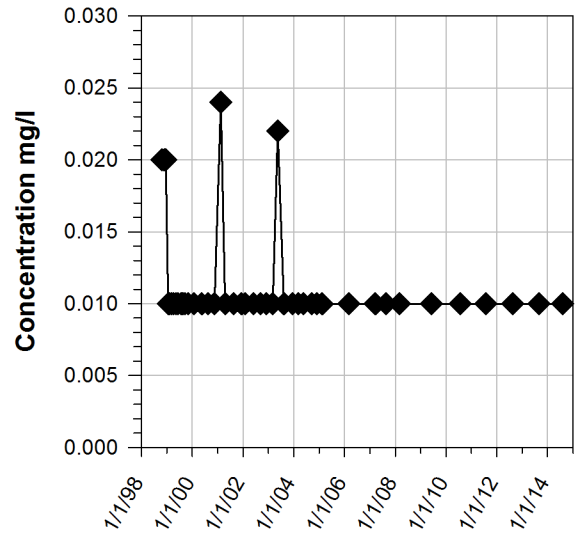

SO4 ECG1184

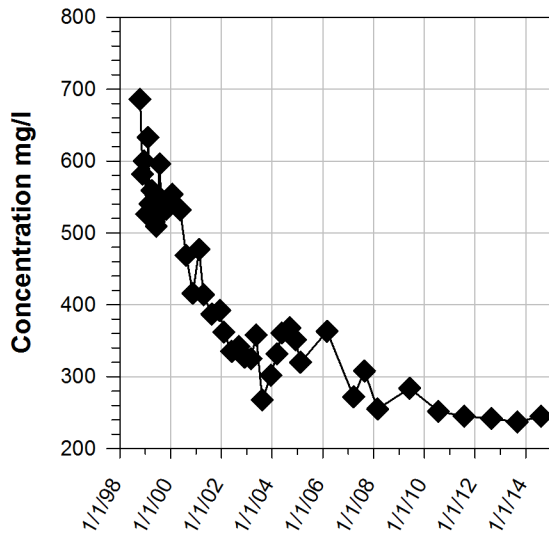

Cd ECG1184

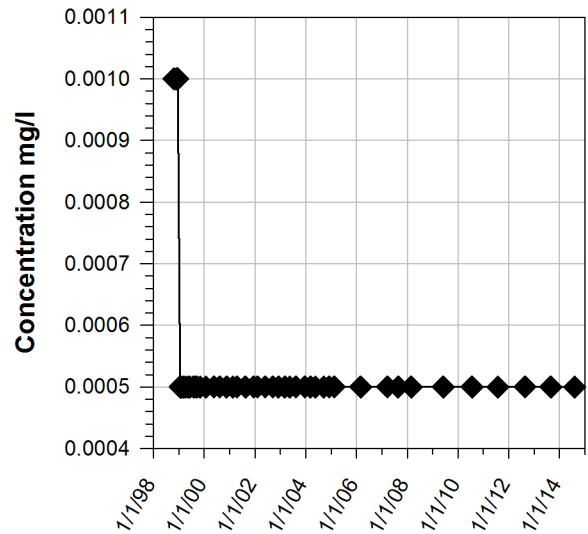

pH ECG1184

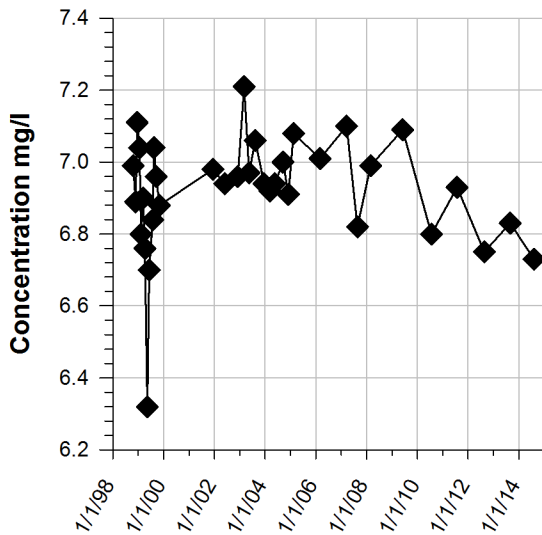

Zn ECG1184

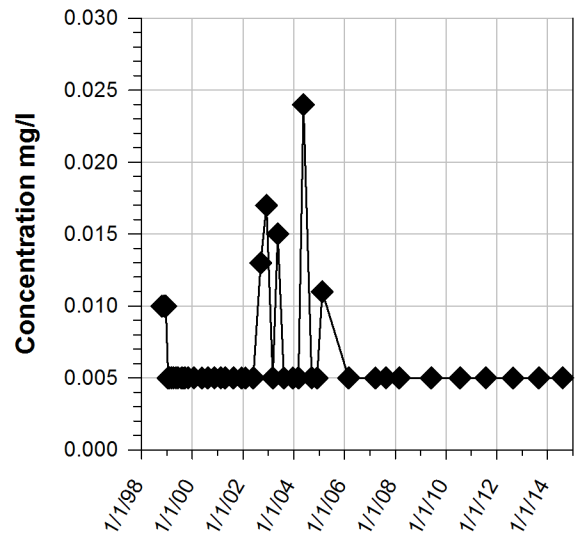

TDS VWP214A

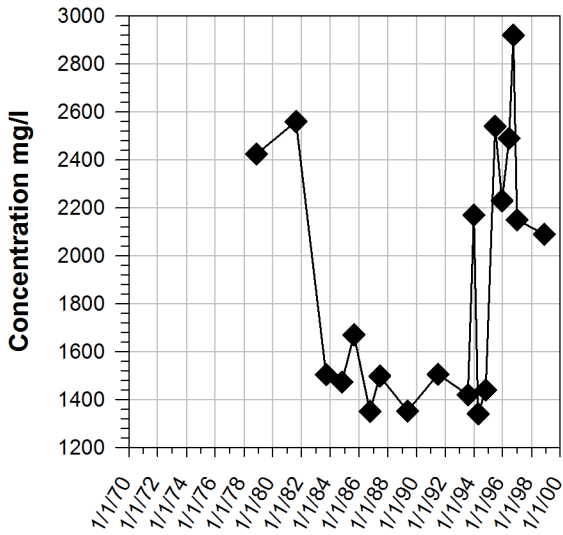

Cu VWP214A

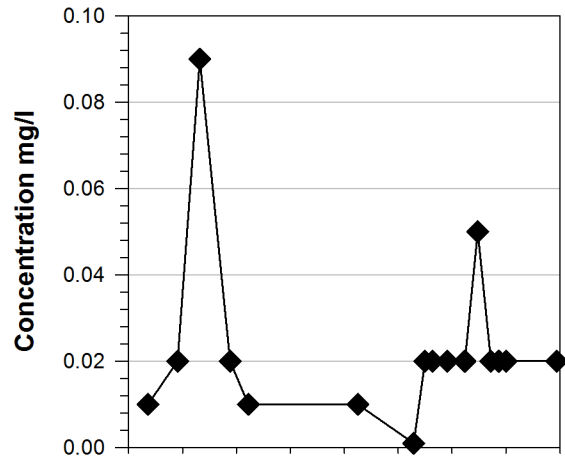

SO4 VWP214A

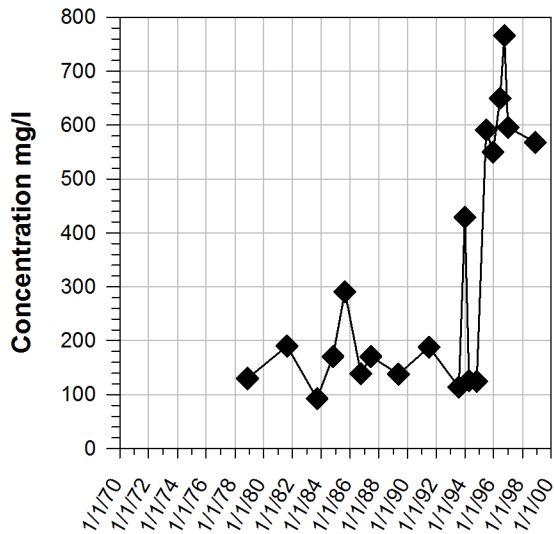

Cd VWP214A

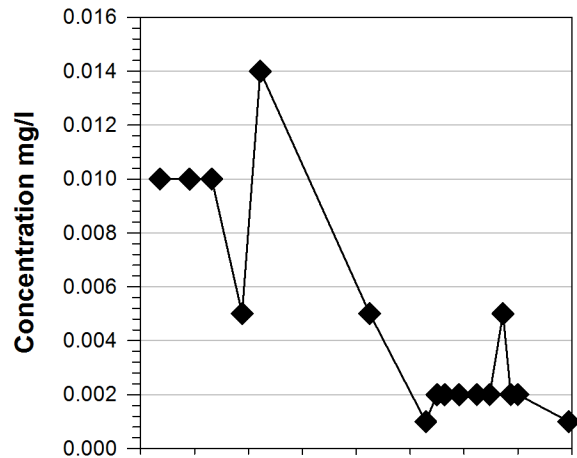

pH VWP214A

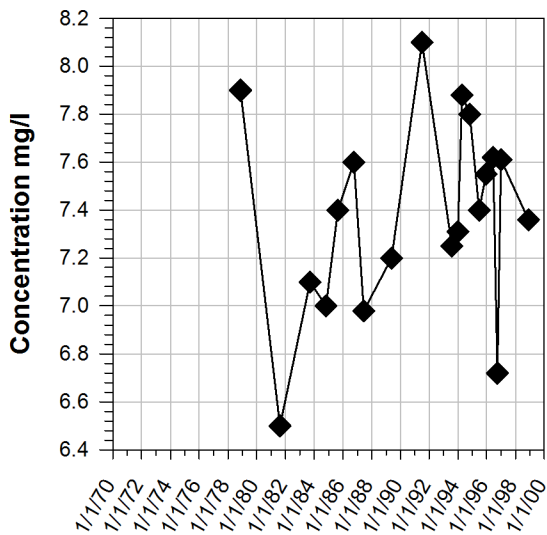

Zn VWP214A

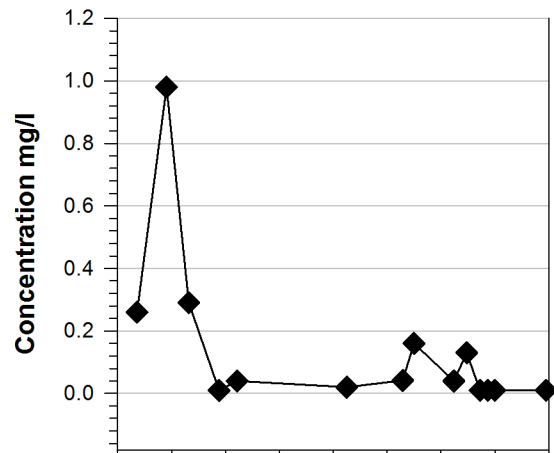

TDS VWP228

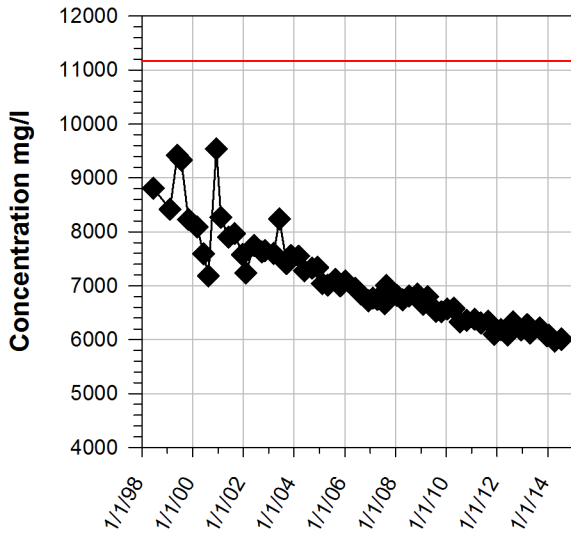

Cu VWP228

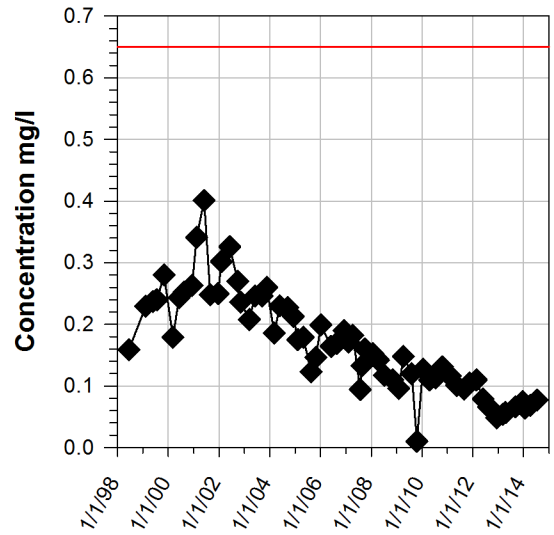

SO4 VWP228

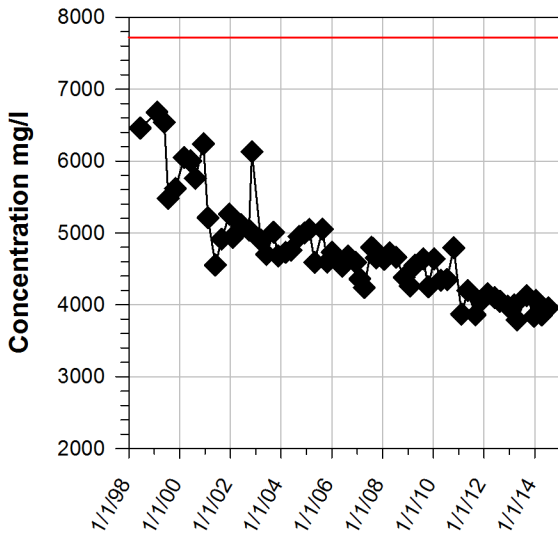

Cd VWP228

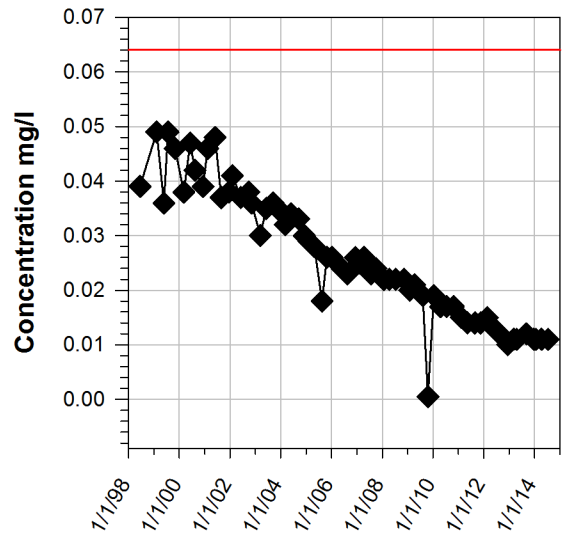

pH VWP228

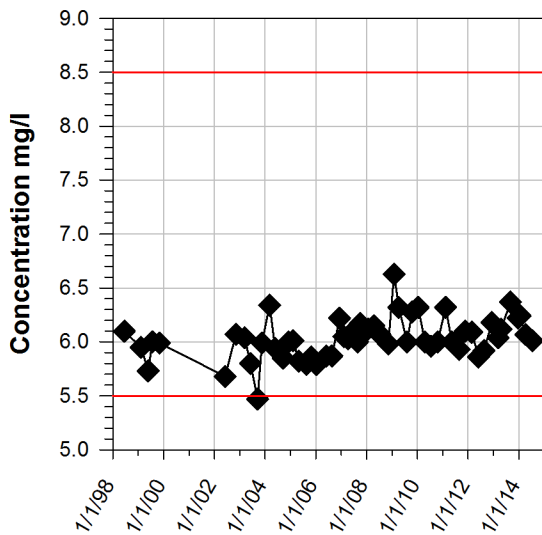

Zn VWP228

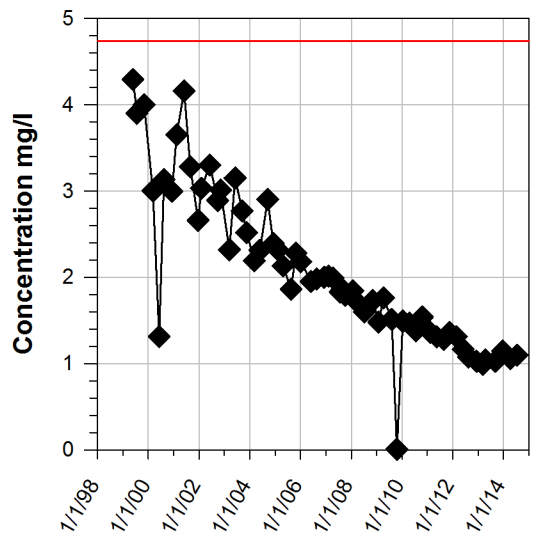

TDS VWP244A

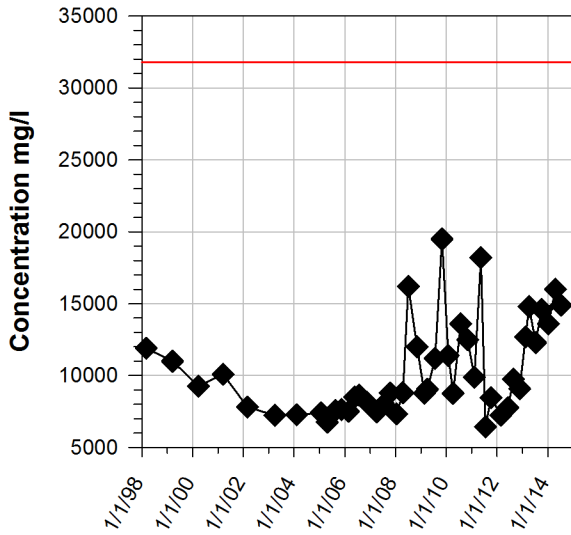

Cu VWP244A

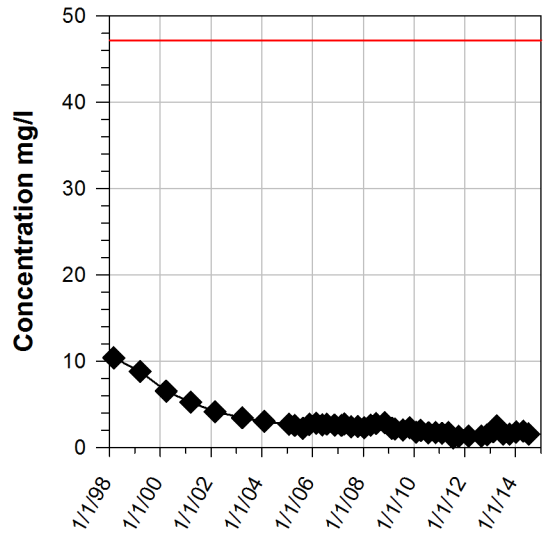

SO4 VWP244A

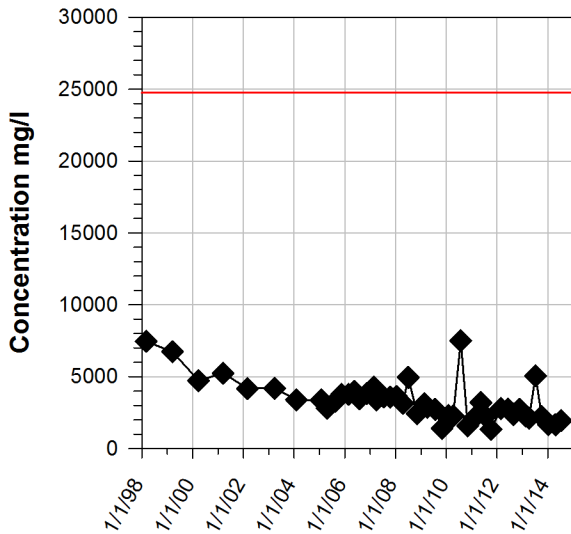

Cd VWP244A

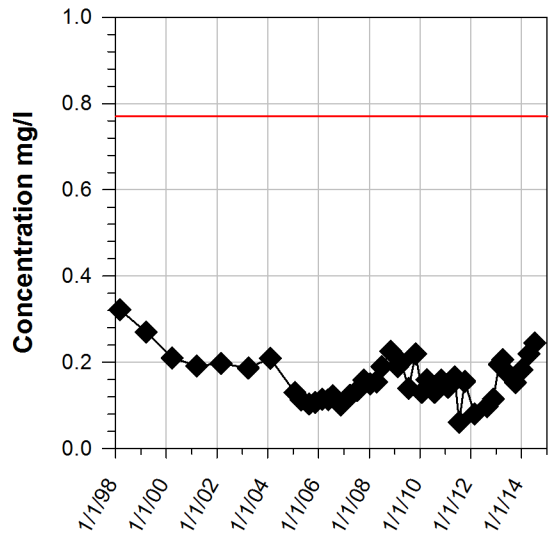

pH VWP244A

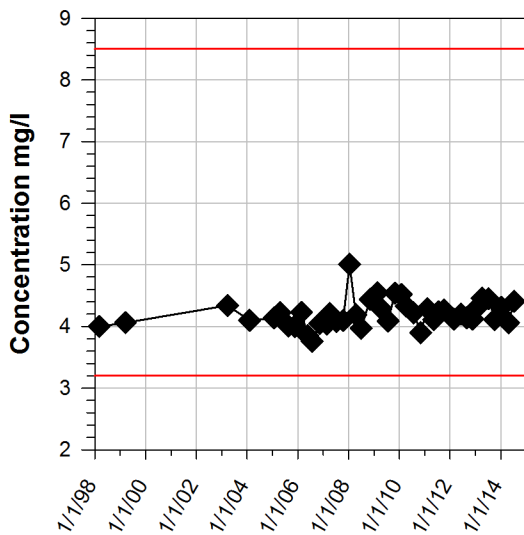

Zn VWP244A

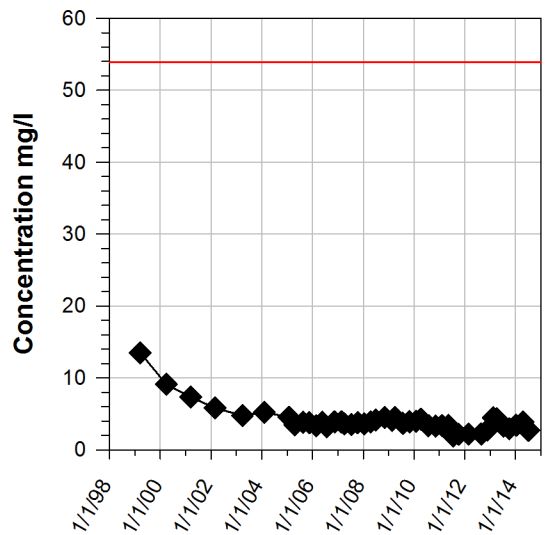

TDS VWP244B

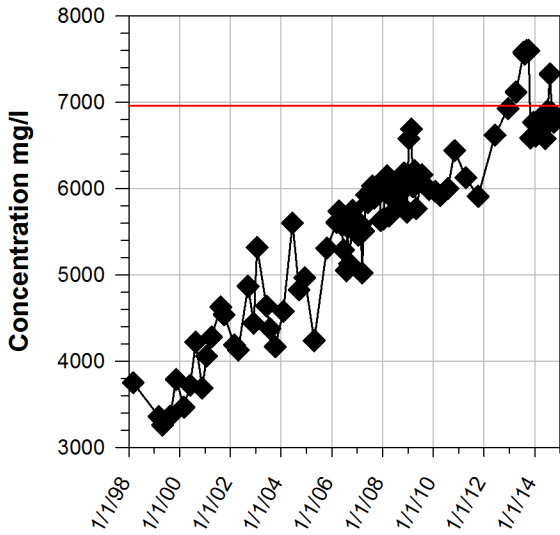

Cu VWP244B

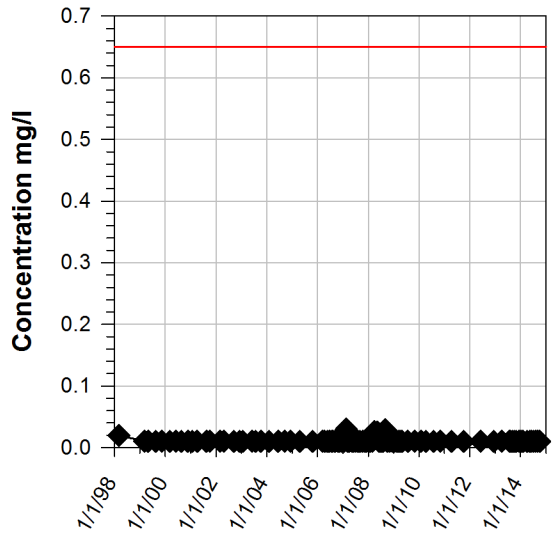

SO4 VWP244B

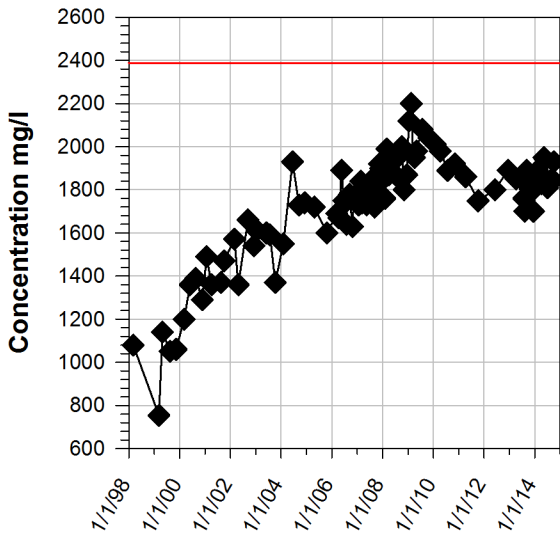

Cd VWP244B

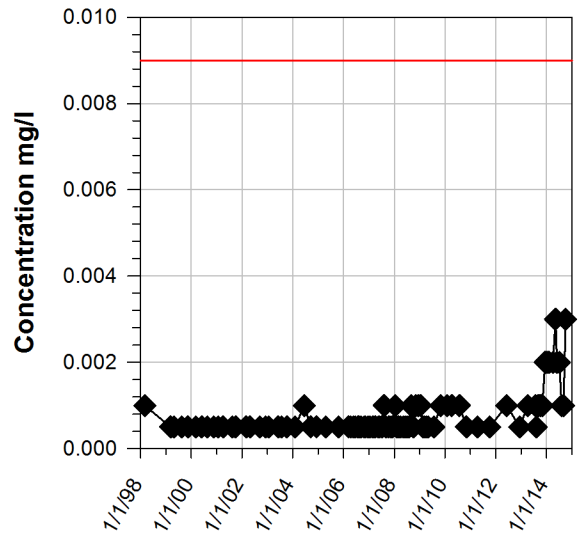

pH VWP244B

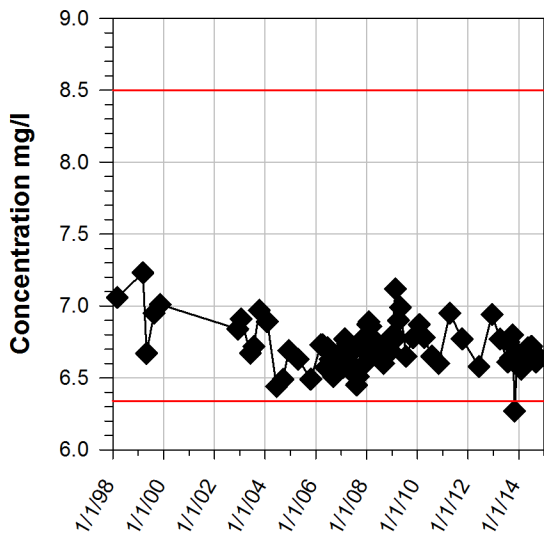

Zn VWP244B

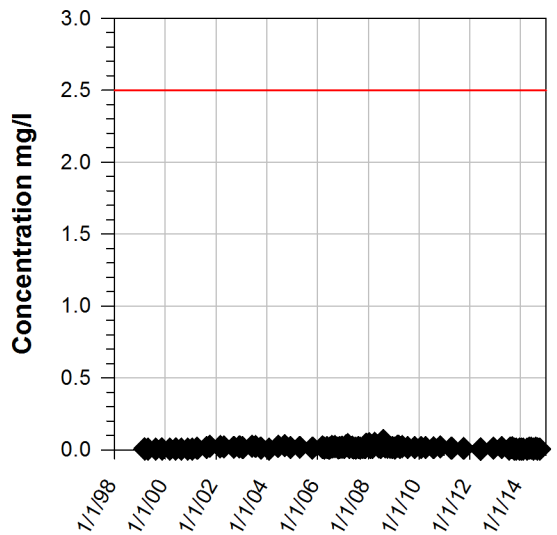

TDS VWP244C

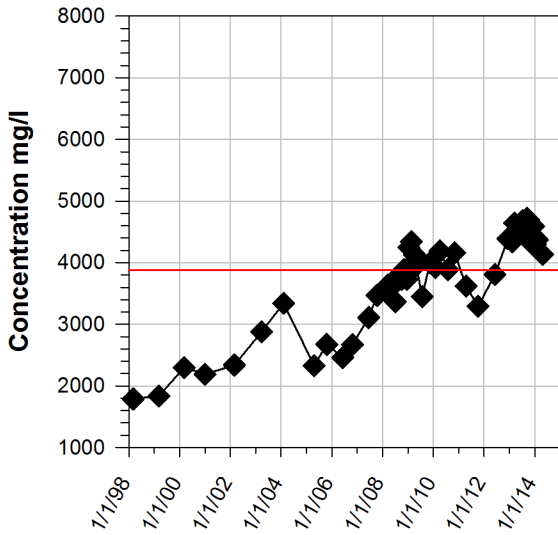

Cu VWP244C

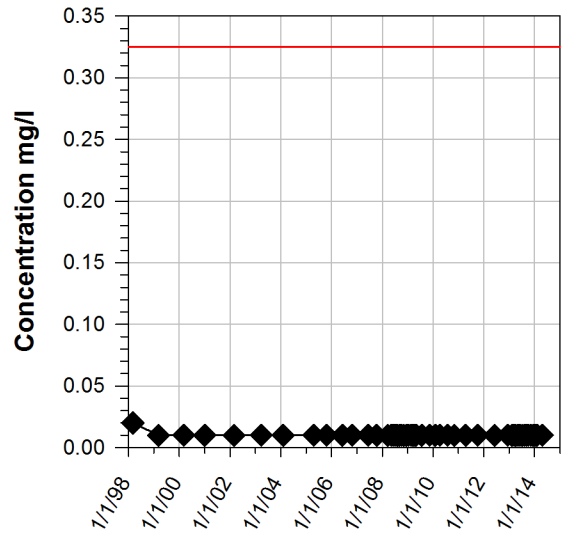

SO4 VWP244C

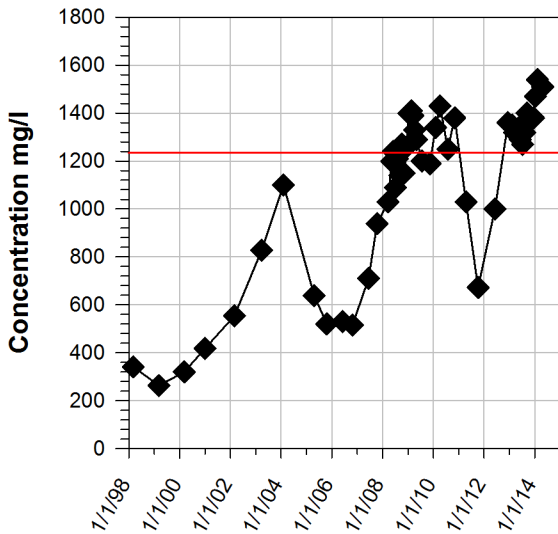

Cd VWP244C

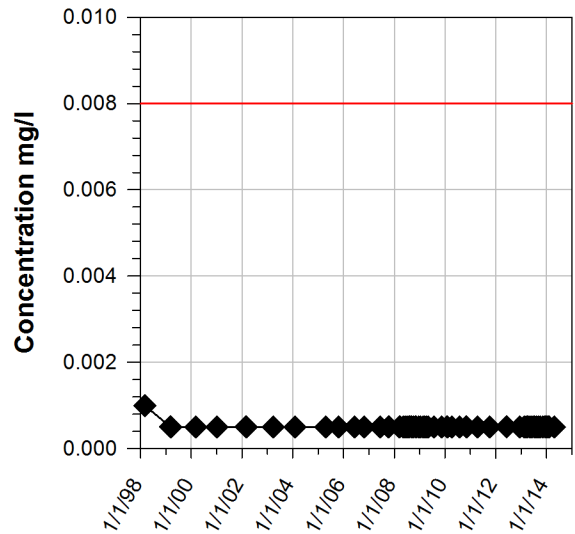

pH VWP244C

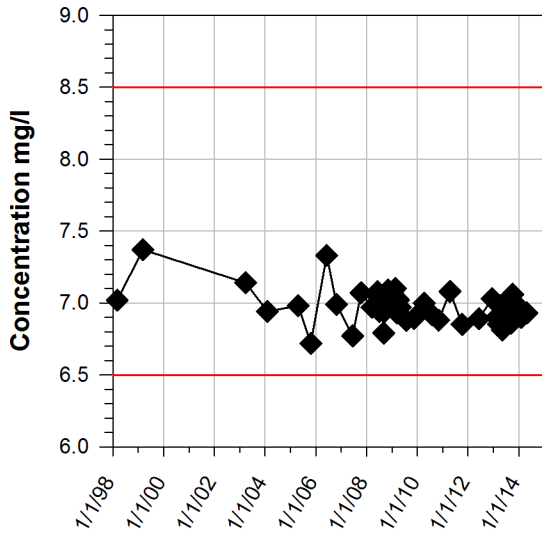

Zn VWP244C

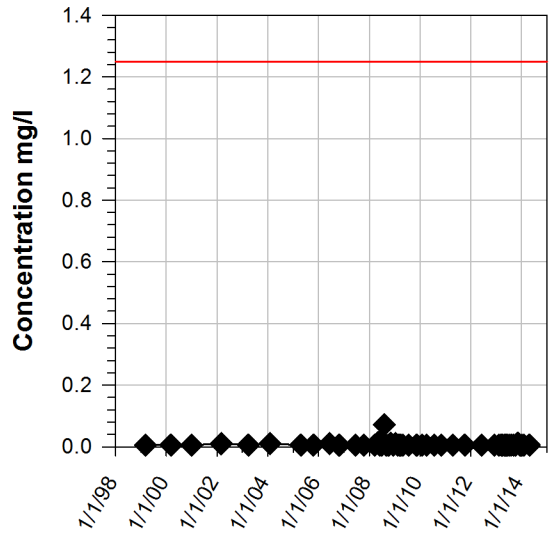

TDS VWP270

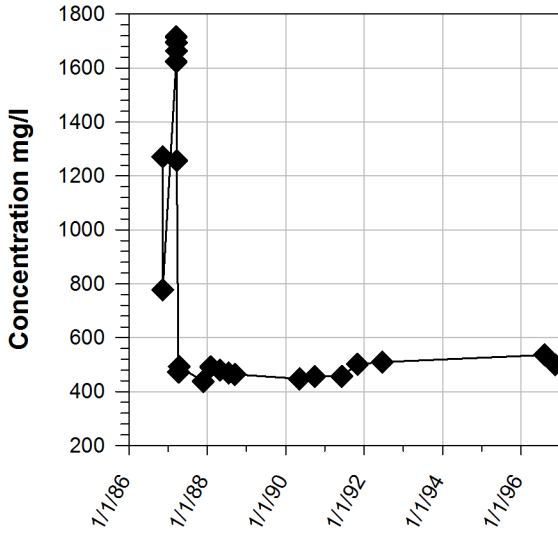

Cu VWP270

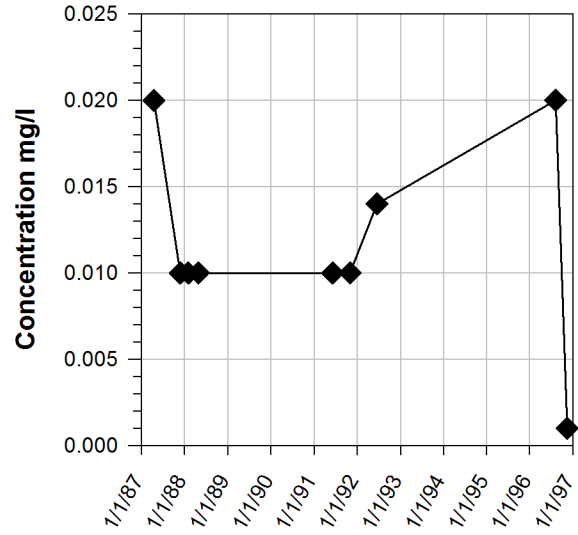

SO4 VWP270

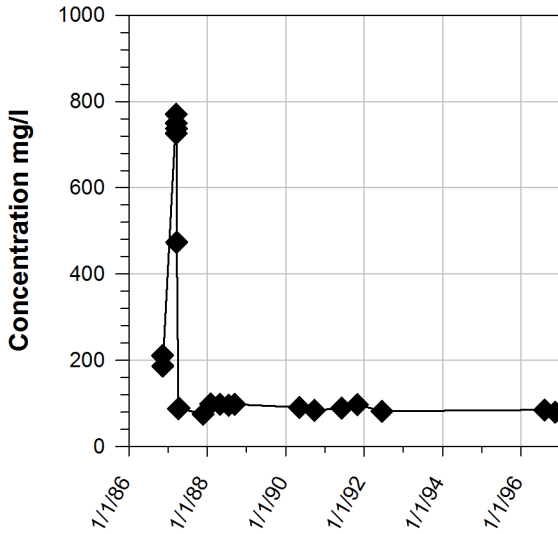

Cd VWP270

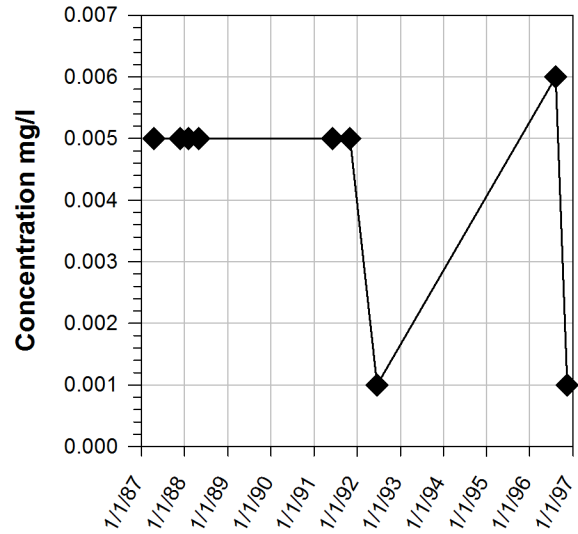

pH VWP270

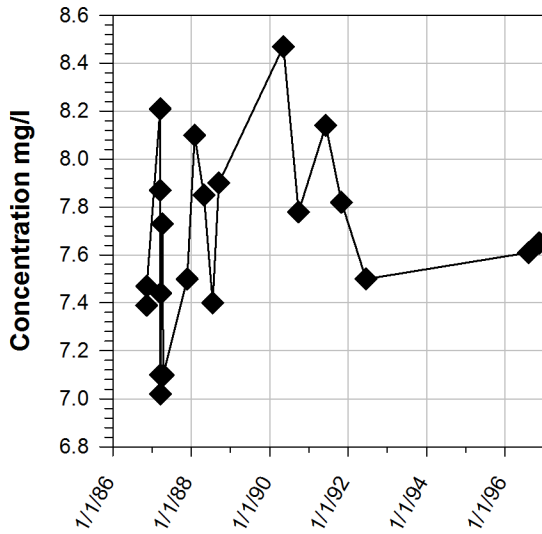

Zn VWP270

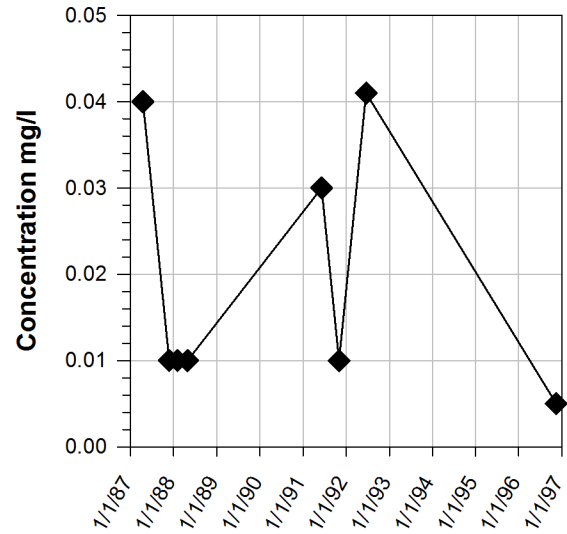

TDS VWP271

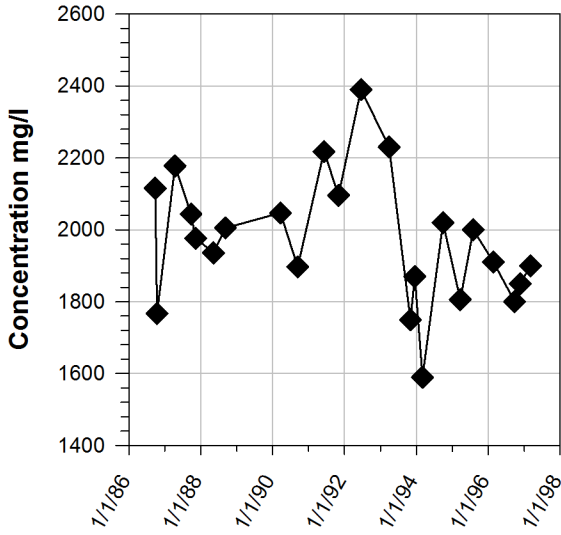

Cu VWP271

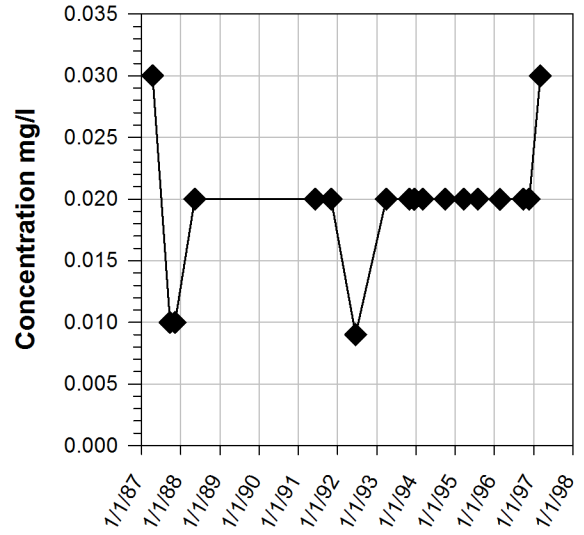

SO4 VWP271

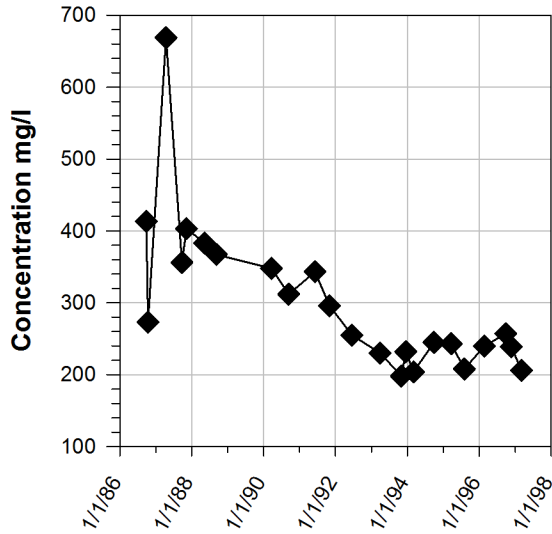

Cd VWP271

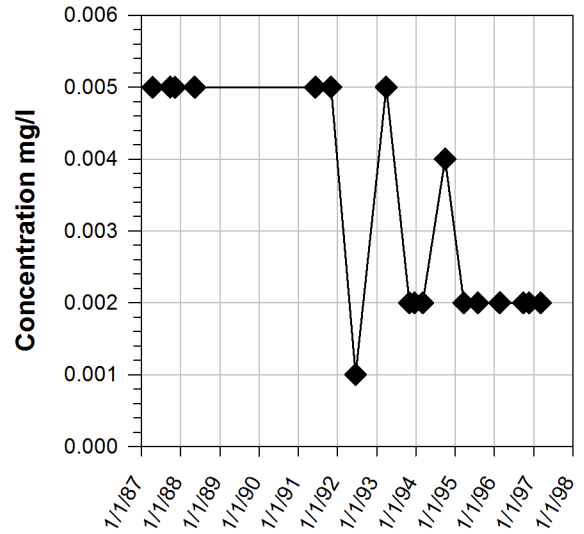

pH VWP271

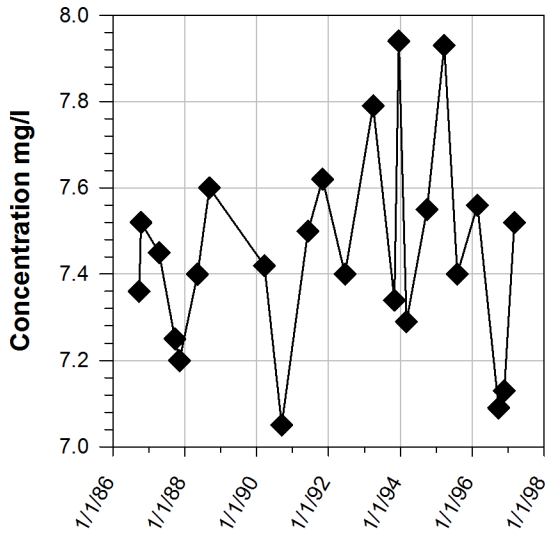

Zn VWP271

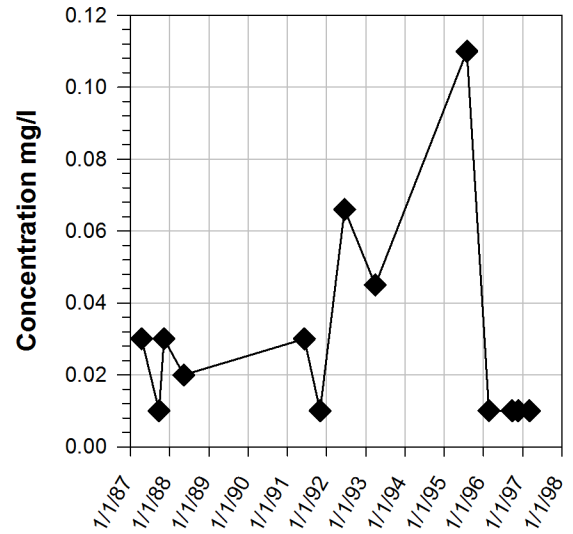

APPENDIX B

**USDA Natural Resources Conservation Service
Custom Soil Report**



United States
Department of
Agriculture

NRCS

Natural
Resources
Conservation
Service

A product of the National
Cooperative Soil Survey,
a joint effort of the United
States Department of
Agriculture and other
Federal agencies, State
agencies including the
Agricultural Experiment
Stations, and local
participants

Custom Soil Resource Report for Salt Lake Area, Utah

South Dumps



Preface

Soil surveys contain information that affects land use planning in survey areas. They highlight soil limitations that affect various land uses and provide information about the properties of the soils in the survey areas. Soil surveys are designed for many different users, including farmers, ranchers, foresters, agronomists, urban planners, community officials, engineers, developers, builders, and home buyers. Also, conservationists, teachers, students, and specialists in recreation, waste disposal, and pollution control can use the surveys to help them understand, protect, or enhance the environment.

Various land use regulations of Federal, State, and local governments may impose special restrictions on land use or land treatment. Soil surveys identify soil properties that are used in making various land use or land treatment decisions. The information is intended to help the land users identify and reduce the effects of soil limitations on various land uses. The landowner or user is responsible for identifying and complying with existing laws and regulations.

Although soil survey information can be used for general farm, local, and wider area planning, onsite investigation is needed to supplement this information in some cases. Examples include soil quality assessments (<http://www.nrcs.usda.gov/wps/portal/nrcs/main/soils/health/>) and certain conservation and engineering applications. For more detailed information, contact your local USDA Service Center (<http://offices.sc.egov.usda.gov/locator/app?agency=nrcs>) or your NRCS State Soil Scientist (http://www.nrcs.usda.gov/wps/portal/nrcs/detail/soils/contactus/?cid=nrcs142p2_053951).

Great differences in soil properties can occur within short distances. Some soils are seasonally wet or subject to flooding. Some are too unstable to be used as a foundation for buildings or roads. Clayey or wet soils are poorly suited to use as septic tank absorption fields. A high water table makes a soil poorly suited to basements or underground installations.

The National Cooperative Soil Survey is a joint effort of the United States Department of Agriculture and other Federal agencies, State agencies including the Agricultural Experiment Stations, and local agencies. The Natural Resources Conservation Service (NRCS) has leadership for the Federal part of the National Cooperative Soil Survey.

Information about soils is updated periodically. Updated information is available through the NRCS Web Soil Survey, the site for official soil survey information.

The U.S. Department of Agriculture (USDA) prohibits discrimination in all its programs and activities on the basis of race, color, national origin, age, disability, and where applicable, sex, marital status, familial status, parental status, religion, sexual orientation, genetic information, political beliefs, reprisal, or because all or a part of an individual's income is derived from any public assistance program. (Not all prohibited bases apply to all programs.) Persons with disabilities who require alternative means

for communication of program information (Braille, large print, audiotape, etc.) should contact USDA's TARGET Center at (202) 720-2600 (voice and TDD). To file a complaint of discrimination, write to USDA, Director, Office of Civil Rights, 1400 Independence Avenue, S.W., Washington, D.C. 20250-9410 or call (800) 795-3272 (voice) or (202) 720-6382 (TDD). USDA is an equal opportunity provider and employer.

Contents

Preface	2
How Soil Surveys Are Made	5
Soil Map	7
Soil Map.....	8
Legend.....	9
Map Unit Legend.....	10
Map Unit Descriptions.....	10
Salt Lake Area, Utah.....	13
BAG—Baird Hollow loam, 30 to 60 percent slopes.....	13
BEG—Bradshaw-Agassiz association, steep.....	14
DRD—Dry Creek soils, 3 to 15 percent slopes.....	16
Du—Dumps.....	18
GEG—Gappmayer very cobbly loam, 30 to 60 percent slopes.....	18
GGG—Gappmayer-Wallsburg association, very steep.....	19
HDF—Harkers-Dry Creek association, moderately steep.....	22
HHF—Harkers soils, 6 to 40 percent slopes.....	24
HNF—Henefer-Horrocks complex, 5 to 50 percent slopes.....	26
HWF—Horrocks extremely stony loam, 5 to 50 percent slopes.....	28
PT—Pits, mine.....	29
WAG—Wallsburg very cobbly loam, 30 to 70 percent slopes.....	29
References	31

How Soil Surveys Are Made

Soil surveys are made to provide information about the soils and miscellaneous areas in a specific area. They include a description of the soils and miscellaneous areas and their location on the landscape and tables that show soil properties and limitations affecting various uses. Soil scientists observed the steepness, length, and shape of the slopes; the general pattern of drainage; the kinds of crops and native plants; and the kinds of bedrock. They observed and described many soil profiles. A soil profile is the sequence of natural layers, or horizons, in a soil. The profile extends from the surface down into the unconsolidated material in which the soil formed or from the surface down to bedrock. The unconsolidated material is devoid of roots and other living organisms and has not been changed by other biological activity.

Currently, soils are mapped according to the boundaries of major land resource areas (MLRAs). MLRAs are geographically associated land resource units that share common characteristics related to physiography, geology, climate, water resources, soils, biological resources, and land uses (USDA, 2006). Soil survey areas typically consist of parts of one or more MLRA.

The soils and miscellaneous areas in a survey area occur in an orderly pattern that is related to the geology, landforms, relief, climate, and natural vegetation of the area. Each kind of soil and miscellaneous area is associated with a particular kind of landform or with a segment of the landform. By observing the soils and miscellaneous areas in the survey area and relating their position to specific segments of the landform, a soil scientist develops a concept, or model, of how they were formed. Thus, during mapping, this model enables the soil scientist to predict with a considerable degree of accuracy the kind of soil or miscellaneous area at a specific location on the landscape.

Commonly, individual soils on the landscape merge into one another as their characteristics gradually change. To construct an accurate soil map, however, soil scientists must determine the boundaries between the soils. They can observe only a limited number of soil profiles. Nevertheless, these observations, supplemented by an understanding of the soil-vegetation-landscape relationship, are sufficient to verify predictions of the kinds of soil in an area and to determine the boundaries.

Soil scientists recorded the characteristics of the soil profiles that they studied. They noted soil color, texture, size and shape of soil aggregates, kind and amount of rock fragments, distribution of plant roots, reaction, and other features that enable them to identify soils. After describing the soils in the survey area and determining their properties, the soil scientists assigned the soils to taxonomic classes (units). Taxonomic classes are concepts. Each taxonomic class has a set of soil characteristics with precisely defined limits. The classes are used as a basis for comparison to classify soils systematically. Soil taxonomy, the system of taxonomic classification used in the United States, is based mainly on the kind and character of soil properties and the arrangement of horizons within the profile. After the soil scientists classified and named the soils in the survey area, they compared the

Custom Soil Resource Report

individual soils with similar soils in the same taxonomic class in other areas so that they could confirm data and assemble additional data based on experience and research.

The objective of soil mapping is not to delineate pure map unit components; the objective is to separate the landscape into landforms or landform segments that have similar use and management requirements. Each map unit is defined by a unique combination of soil components and/or miscellaneous areas in predictable proportions. Some components may be highly contrasting to the other components of the map unit. The presence of minor components in a map unit in no way diminishes the usefulness or accuracy of the data. The delineation of such landforms and landform segments on the map provides sufficient information for the development of resource plans. If intensive use of small areas is planned, onsite investigation is needed to define and locate the soils and miscellaneous areas.

Soil scientists make many field observations in the process of producing a soil map. The frequency of observation is dependent upon several factors, including scale of mapping, intensity of mapping, design of map units, complexity of the landscape, and experience of the soil scientist. Observations are made to test and refine the soil-landscape model and predictions and to verify the classification of the soils at specific locations. Once the soil-landscape model is refined, a significantly smaller number of measurements of individual soil properties are made and recorded. These measurements may include field measurements, such as those for color, depth to bedrock, and texture, and laboratory measurements, such as those for content of sand, silt, clay, salt, and other components. Properties of each soil typically vary from one point to another across the landscape.

Observations for map unit components are aggregated to develop ranges of characteristics for the components. The aggregated values are presented. Direct measurements do not exist for every property presented for every map unit component. Values for some properties are estimated from combinations of other properties.

While a soil survey is in progress, samples of some of the soils in the area generally are collected for laboratory analyses and for engineering tests. Soil scientists interpret the data from these analyses and tests as well as the field-observed characteristics and the soil properties to determine the expected behavior of the soils under different uses. Interpretations for all of the soils are field tested through observation of the soils in different uses and under different levels of management. Some interpretations are modified to fit local conditions, and some new interpretations are developed to meet local needs. Data are assembled from other sources, such as research information, production records, and field experience of specialists. For example, data on crop yields under defined levels of management are assembled from farm records and from field or plot experiments on the same kinds of soil.

Predictions about soil behavior are based not only on soil properties but also on such variables as climate and biological activity. Soil conditions are predictable over long periods of time, but they are not predictable from year to year. For example, soil scientists can predict with a fairly high degree of accuracy that a given soil will have a high water table within certain depths in most years, but they cannot predict that a high water table will always be at a specific level in the soil on a specific date.

After soil scientists located and identified the significant natural bodies of soil in the survey area, they drew the boundaries of these bodies on aerial photographs and identified each as a specific map unit. Aerial photographs show trees, buildings, fields, roads, and rivers, all of which help in locating boundaries accurately.

Soil Map

The soil map section includes the soil map for the defined area of interest, a list of soil map units on the map and extent of each map unit, and cartographic symbols displayed on the map. Also presented are various metadata about data used to produce the map, and a description of each soil map unit.

Custom Soil Resource Report Soil Map

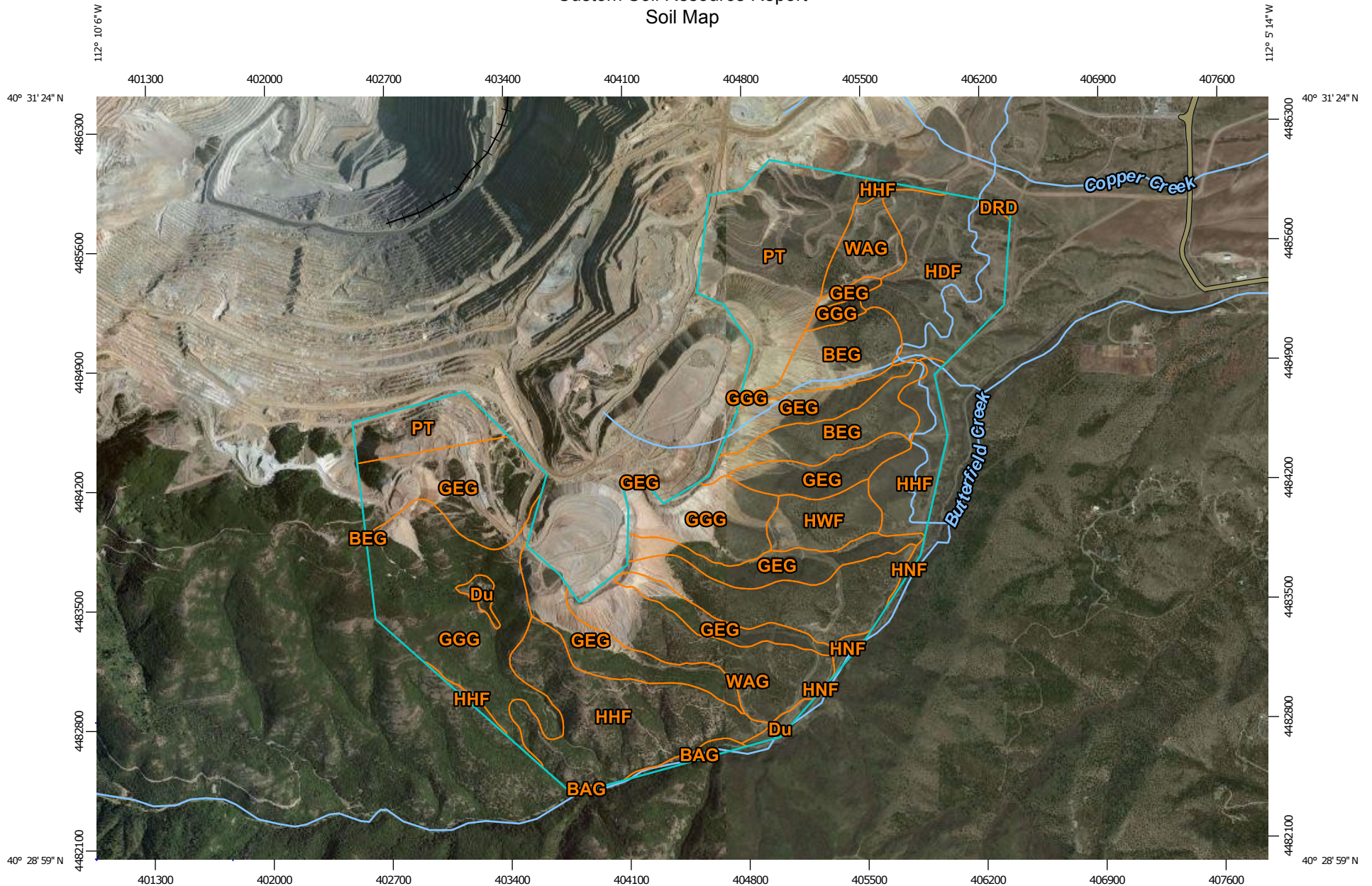

Map Scale: 1:31,500 if printed on A landscape (11" x 8.5") sheet.

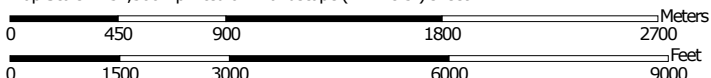

Map projection: Web Mercator Corner coordinates: WGS84 Edge tics: UTM Zone 12N WGS84

MAP LEGEND

Area of Interest (AOI)

 Area of Interest (AOI)



















Soils







 Soil Map Unit Polygons

 Soil Map Unit Lines

 Soil Map Unit Points

Special Point Features





-  Blowout
-  Borrow Pit
-  Clay Spot
-  Closed Depression
-  Gravel Pit
-  Gravelly Spot
-  Landfill
-  Lava Flow
-  Marsh or swamp
-  Mine or Quarry
-  Miscellaneous Water
-  Perennial Water
-  Rock Outcrop
-  Saline Spot
-  Sandy Spot
-  Severely Eroded Spot
-  Sinkhole
-  Slide or Slip
-  Sodic Spot

-  Spoil Area
-  Stony Spot
-  Very Stony Spot
-  Wet Spot
-  Other
-  Special Line Features

Water Features

 Streams and Canals

Transportation

-  Rails
-  Interstate Highways
-  US Routes
-  Major Roads
-  Local Roads

Background

 Aerial Photography

MAP INFORMATION

The soil surveys that comprise your AOI were mapped at 1:20,000.

Please rely on the bar scale on each map sheet for map measurements.

Source of Map: Natural Resources Conservation Service
 Web Soil Survey URL: <http://websoilsurvey.nrcs.usda.gov>
 Coordinate System: Web Mercator (EPSG:3857)

Maps from the Web Soil Survey are based on the Web Mercator projection, which preserves direction and shape but distorts distance and area. A projection that preserves area, such as the Albers equal-area conic projection, should be used if more accurate calculations of distance or area are required.

This product is generated from the USDA-NRCS certified data as of the version date(s) listed below.

Soil Survey Area: Salt Lake Area, Utah
 Survey Area Data: Version 7, Aug 5, 2014

Soil map units are labeled (as space allows) for map scales 1:50,000 or larger.

Date(s) aerial images were photographed: May 2, 2011—Apr 28, 2012

The orthophoto or other base map on which the soil lines were compiled and digitized probably differs from the background imagery displayed on these maps. As a result, some minor shifting of map unit boundaries may be evident.

Map Unit Legend

Salt Lake Area, Utah (UT612)			
Map Unit Symbol	Map Unit Name	Acres in AOI	Percent of AOI
BAG	Baird Hollow loam, 30 to 60 percent slopes	9.8	0.6%
BEG	Bradshaw-Agassiz association, steep	126.2	7.1%
DRD	Dry Creek soils, 3 to 15 percent slopes	2.3	0.1%
Du	Dumps	14.7	0.8%
GEG	Gappmayer very cobbly loam, 30 to 60 percent slopes	376.2	21.2%
GGG	Gappmayer-Wallsburg association, very steep	289.3	16.3%
HDF	Harkers-Dry Creek association, moderately steep	147.2	8.3%
HHF	Harkers soils, 6 to 40 percent slopes	247.1	13.9%
HNF	Henefer-Horrocks complex, 5 to 50 percent slopes	9.2	0.5%
HWF	Horrocks extremely stony loam, 5 to 50 percent slopes	48.1	2.7%
PT	Pits, mine	245.2	13.8%
WAG	Wallsburg very cobbly loam, 30 to 70 percent slopes	258.0	14.6%
Totals for Area of Interest		1,773.2	100.0%

Map Unit Descriptions

The map units delineated on the detailed soil maps in a soil survey represent the soils or miscellaneous areas in the survey area. The map unit descriptions, along with the maps, can be used to determine the composition and properties of a unit.

A map unit delineation on a soil map represents an area dominated by one or more major kinds of soil or miscellaneous areas. A map unit is identified and named according to the taxonomic classification of the dominant soils. Within a taxonomic class there are precisely defined limits for the properties of the soils. On the landscape, however, the soils are natural phenomena, and they have the characteristic variability of all natural phenomena. Thus, the range of some observed properties may extend beyond the limits defined for a taxonomic class. Areas of soils of a single taxonomic class rarely, if ever, can be mapped without including areas of other taxonomic classes. Consequently, every map unit is made up of the soils or miscellaneous areas for which it is named and some minor components that belong to taxonomic classes other than those of the major soils.

Custom Soil Resource Report

Most minor soils have properties similar to those of the dominant soil or soils in the map unit, and thus they do not affect use and management. These are called noncontrasting, or similar, components. They may or may not be mentioned in a particular map unit description. Other minor components, however, have properties and behavioral characteristics divergent enough to affect use or to require different management. These are called contrasting, or dissimilar, components. They generally are in small areas and could not be mapped separately because of the scale used. Some small areas of strongly contrasting soils or miscellaneous areas are identified by a special symbol on the maps. If included in the database for a given area, the contrasting minor components are identified in the map unit descriptions along with some characteristics of each. A few areas of minor components may not have been observed, and consequently they are not mentioned in the descriptions, especially where the pattern was so complex that it was impractical to make enough observations to identify all the soils and miscellaneous areas on the landscape.

The presence of minor components in a map unit in no way diminishes the usefulness or accuracy of the data. The objective of mapping is not to delineate pure taxonomic classes but rather to separate the landscape into landforms or landform segments that have similar use and management requirements. The delineation of such segments on the map provides sufficient information for the development of resource plans. If intensive use of small areas is planned, however, onsite investigation is needed to define and locate the soils and miscellaneous areas.

An identifying symbol precedes the map unit name in the map unit descriptions. Each description includes general facts about the unit and gives important soil properties and qualities.

Soils that have profiles that are almost alike make up a *soil series*. Except for differences in texture of the surface layer, all the soils of a series have major horizons that are similar in composition, thickness, and arrangement.

Soils of one series can differ in texture of the surface layer, slope, stoniness, salinity, degree of erosion, and other characteristics that affect their use. On the basis of such differences, a soil series is divided into *soil phases*. Most of the areas shown on the detailed soil maps are phases of soil series. The name of a soil phase commonly indicates a feature that affects use or management. For example, Alpha silt loam, 0 to 2 percent slopes, is a phase of the Alpha series.

Some map units are made up of two or more major soils or miscellaneous areas. These map units are complexes, associations, or undifferentiated groups.

A *complex* consists of two or more soils or miscellaneous areas in such an intricate pattern or in such small areas that they cannot be shown separately on the maps. The pattern and proportion of the soils or miscellaneous areas are somewhat similar in all areas. Alpha-Beta complex, 0 to 6 percent slopes, is an example.

An *association* is made up of two or more geographically associated soils or miscellaneous areas that are shown as one unit on the maps. Because of present or anticipated uses of the map units in the survey area, it was not considered practical or necessary to map the soils or miscellaneous areas separately. The pattern and relative proportion of the soils or miscellaneous areas are somewhat similar. Alpha-Beta association, 0 to 2 percent slopes, is an example.

An *undifferentiated group* is made up of two or more soils or miscellaneous areas that could be mapped individually but are mapped as one unit because similar interpretations can be made for use and management. The pattern and proportion of the soils or miscellaneous areas in a mapped area are not uniform. An area can be

Custom Soil Resource Report

made up of only one of the major soils or miscellaneous areas, or it can be made up of all of them. Alpha and Beta soils, 0 to 2 percent slopes, is an example.

Some surveys include *miscellaneous areas*. Such areas have little or no soil material and support little or no vegetation. Rock outcrop is an example.

Salt Lake Area, Utah

BAG—Baird Hollow loam, 30 to 60 percent slopes

Map Unit Setting

National map unit symbol: j6gh
Elevation: 6,000 to 8,000 feet
Mean annual precipitation: 25 to 35 inches
Mean annual air temperature: 41 to 43 degrees F
Frost-free period: 60 to 80 days
Farmland classification: Not prime farmland

Map Unit Composition

Baird hollow and similar soils: 95 percent
Minor components: 5 percent
Estimates are based on observations, descriptions, and transects of the mapunit.

Description of Baird Hollow

Setting

Landform: Mountain slopes
Landform position (three-dimensional): Mountainflank
Down-slope shape: Convex
Across-slope shape: Convex
Parent material: Colluvium derived from andesite over residuum weathered from andesite

Typical profile

A11 - 0 to 8 inches: loam
A12 - 8 to 18 inches: gravelly loam
A2 - 18 to 24 inches: cobbly silt loam
B&A - 24 to 32 inches: cobbly silty clay loam
B21t - 32 to 52 inches: very cobbly clay
B22t&B3t - 52 to 76 inches: very gravelly sandy clay loam

Properties and qualities

Slope: 30 to 60 percent
Depth to restrictive feature: More than 80 inches
Natural drainage class: Well drained
Capacity of the most limiting layer to transmit water (Ksat): Moderately high (0.20 to 0.60 in/hr)
Depth to water table: More than 80 inches
Frequency of flooding: None
Frequency of ponding: None
Available water storage in profile: Moderate (about 7.3 inches)

Interpretive groups

Land capability classification (irrigated): None specified
Land capability classification (nonirrigated): 7e
Hydrologic Soil Group: C
Ecological site: Populus tremuloides/symphoricarpos oreophilus/bromus carinatus (F047XA508UT)

Minor Components

Little pole

Percent of map unit: 5 percent

BEG—Bradshaw-Agassiz association, steep

Map Unit Setting

*National map unit symbol: j6gd
Elevation: 6,000 to 8,500 feet
Mean annual precipitation: 18 to 25 inches
Mean annual air temperature: 44 to 46 degrees F
Frost-free period: 80 to 100 days
Farmland classification: Not prime farmland*

Map Unit Composition

*Bradshaw and similar soils: 55 percent
Agassiz and similar soils: 35 percent
Minor components: 10 percent
Estimates are based on observations, descriptions, and transects of the mapunit.*

Description of Bradshaw

Setting

*Landform: Mountain slopes
Landform position (three-dimensional): Mountainflank
Down-slope shape: Convex
Across-slope shape: Convex
Parent material: Colluvium derived from limestone, sandstone, and shale*

Typical profile

*A11 - 0 to 9 inches: very cobbly silt loam
A12 - 9 to 20 inches: very cobbly silt loam
B2 - 20 to 52 inches: very cobbly silt loam
C1 - 52 to 72 inches: extremely cobbly silt loam*

Properties and qualities

*Slope: 40 to 70 percent
Depth to restrictive feature: More than 80 inches
Natural drainage class: Well drained
Capacity of the most limiting layer to transmit water (Ksat): Moderately high to high
(0.60 to 2.00 in/hr)
Depth to water table: More than 80 inches
Frequency of flooding: None
Frequency of ponding: None
Calcium carbonate, maximum in profile: 15 percent
Salinity, maximum in profile: Nonsaline (0.0 to 2.0 mmhos/cm)
Available water storage in profile: Low (about 5.7 inches)*

Custom Soil Resource Report

Interpretive groups

Land capability classification (irrigated): None specified

Land capability classification (nonirrigated): 7s

Hydrologic Soil Group: B

Ecological site: Mountain stony loam (antelope bitterbrush) (R047XA456UT)

Description of Agassiz

Setting

Landform: Ridges on mountain slopes

Landform position (two-dimensional): Summit

Landform position (three-dimensional): Mountainflank, interfluve, crest

Down-slope shape: Convex

Across-slope shape: Convex

Parent material: Colluvium derived from limestone, sandstone, and shale and/or residuum weathered from limestone, sandstone, and shale

Typical profile

A1 - 0 to 7 inches: very cobbly silt loam

C1 - 7 to 15 inches: very cobbly silt loam

R - 15 to 25 inches: unweathered bedrock

Properties and qualities

Slope: 40 to 70 percent

Depth to restrictive feature: 12 to 20 inches to lithic bedrock

Natural drainage class: Well drained

Capacity of the most limiting layer to transmit water (Ksat): Very low to moderately high (0.00 to 0.20 in/hr)

Depth to water table: More than 80 inches

Frequency of flooding: None

Frequency of ponding: None

Calcium carbonate, maximum in profile: 3 percent

Available water storage in profile: Very low (about 1.6 inches)

Interpretive groups

Land capability classification (irrigated): None specified

Land capability classification (nonirrigated): 7s

Hydrologic Soil Group: D

Ecological site: Mountain shallow loam (mountain big sagebrush) (R047XA446UT)

Minor Components

Rock outcrop

Percent of map unit: 5 percent

Daybell

Percent of map unit: 3 percent

Gappmayer

Percent of map unit: 2 percent

DRD—Dry Creek soils, 3 to 15 percent slopes

Map Unit Setting

National map unit symbol: j6h9
Elevation: 4,100 to 6,000 feet
Mean annual precipitation: 17 to 19 inches
Mean annual air temperature: 46 to 48 degrees F
Frost-free period: 130 to 150 days
Farmland classification: Not prime farmland

Map Unit Composition

Dry creek and similar soils: 45 percent
Dry creek and similar soils: 45 percent
Minor components: 10 percent
Estimates are based on observations, descriptions, and transects of the mapunit.

Description of Dry Creek

Setting

Landform: Alluvial fans
Down-slope shape: Concave
Across-slope shape: Convex
Parent material: Alluvium derived from limestone, sandstone, and shale

Typical profile

AP - 0 to 6 inches: silt loam
A1 - 6 to 11 inches: silt loam
B1t - 11 to 15 inches: silty clay loam
B2t - 15 to 29 inches: silty clay
B3tca - 29 to 42 inches: silty clay loam
Cca - 42 to 60 inches: silt loam

Properties and qualities

Slope: 3 to 15 percent
Depth to restrictive feature: More than 80 inches
Natural drainage class: Well drained
Capacity of the most limiting layer to transmit water (Ksat): Moderately low to moderately high (0.06 to 0.20 in/hr)
Depth to water table: More than 80 inches
Frequency of flooding: None
Frequency of ponding: None
Calcium carbonate, maximum in profile: 30 percent
Salinity, maximum in profile: Nonsaline (0.0 to 2.0 mmhos/cm)
Sodium adsorption ratio, maximum in profile: 30.0
Available water storage in profile: High (about 10.2 inches)

Interpretive groups

Land capability classification (irrigated): None specified
Land capability classification (nonirrigated): 3e

Custom Soil Resource Report

Hydrologic Soil Group: C

Ecological site: Upland loam (bonneville big sagebrush) north (R028AY310UT)

Other vegetative classification: Upland Loam (Mountain Big Sagebrush)
(028AY310UT)

Description of Dry Creek

Setting

Landform: Alluvial fans

Down-slope shape: Concave

Across-slope shape: Convex

Parent material: Alluvium derived from limestone, sandstone, and shale

Typical profile

Ap - 0 to 6 inches: gravelly loam

A1 - 6 to 11 inches: gravelly loam

B1t - 11 to 15 inches: gravelly silty clay loam

B2t - 15 to 29 inches: gravelly silty clay

B3tca - 29 to 42 inches: gravelly silty clay loam

Cca - 42 to 60 inches: very gravelly silt loam

Properties and qualities

Slope: 3 to 15 percent

Depth to restrictive feature: More than 80 inches

Natural drainage class: Well drained

Capacity of the most limiting layer to transmit water (Ksat): Moderately low to moderately high (0.06 to 0.20 in/hr)

Depth to water table: More than 80 inches

Frequency of flooding: None

Frequency of ponding: None

Calcium carbonate, maximum in profile: 30 percent

Salinity, maximum in profile: Nonsaline (0.0 to 2.0 mmhos/cm)

Sodium adsorption ratio, maximum in profile: 30.0

Available water storage in profile: Moderate (about 8.1 inches)

Interpretive groups

Land capability classification (irrigated): None specified

Land capability classification (nonirrigated): 3e

Hydrologic Soil Group: C

Ecological site: Upland loam (bonneville big sagebrush) north (R028AY310UT)

Other vegetative classification: Upland Loam (Mountain Big Sagebrush)
(028AY310UT)

Minor Components

Copperton

Percent of map unit: 10 percent

Landform: Ridges, terraces

Ecological site: Upland gravelly loam (bonneville big sagebrush) (R028AY306UT)

Du—Dumps

Map Unit Setting

National map unit symbol: j6hg

Elevation: 4,200 to 9,000 feet

Farmland classification: Not prime farmland

Map Unit Composition

Dumps: 100 percent

Estimates are based on observations, descriptions, and transects of the mapunit.

GEG—Gappmayer very cobbly loam, 30 to 60 percent slopes

Map Unit Setting

National map unit symbol: j6hl

Elevation: 5,500 to 7,500 feet

Mean annual precipitation: 20 to 25 inches

Mean annual air temperature: 44 to 46 degrees F

Frost-free period: 80 to 100 days

Farmland classification: Not prime farmland

Map Unit Composition

Gappmayer and similar soils: 85 percent

Minor components: 15 percent

Estimates are based on observations, descriptions, and transects of the mapunit.

Description of Gappmayer

Setting

Landform: Mountain slopes

Landform position (three-dimensional): Mountainflank

Down-slope shape: Convex

Across-slope shape: Convex

Parent material: Colluvium derived from limestone, sandstone, and shale and/or residuum weathered from limestone, sandstone, and shale

Typical profile

A1 - 0 to 10 inches: very cobbly loam

A12 - 10 to 16 inches: very gravelly silt loam

A2 - 16 to 20 inches: very gravelly silt loam

B21t - 20 to 26 inches: very gravelly silty clay loam

B22t - 26 to 44 inches: extremely gravelly clay loam

C1 - 44 to 72 inches: very gravelly silt loam

Custom Soil Resource Report

Properties and qualities

Slope: 30 to 60 percent

Depth to restrictive feature: More than 80 inches

Natural drainage class: Well drained

Capacity of the most limiting layer to transmit water (Ksat): Moderately high (0.20 to 0.60 in/hr)

Depth to water table: More than 80 inches

Frequency of flooding: None

Frequency of ponding: None

Available water storage in profile: Low (about 5.5 inches)

Interpretive groups

Land capability classification (irrigated): None specified

Land capability classification (nonirrigated): 7e

Hydrologic Soil Group: C

Ecological site: Mountain gravelly loam (oak) (R047XA410UT)

Minor Components

Harkers

Percent of map unit: 5 percent

Gappmayer

Percent of map unit: 5 percent

Wallsburg

Percent of map unit: 5 percent

GGG—Gappmayer-Wallsburg association, very steep

Map Unit Setting

National map unit symbol: j6hm

Elevation: 5,500 to 7,500 feet

Mean annual precipitation: 20 to 25 inches

Mean annual air temperature: 44 to 46 degrees F

Frost-free period: 80 to 120 days

Farmland classification: Not prime farmland

Map Unit Composition

Gappmayer and similar soils: 35 percent

Wallsburg and similar soils: 30 percent

Horrocks and similar soils: 25 percent

Minor components: 10 percent

Estimates are based on observations, descriptions, and transects of the mapunit.

Description of Gappmayer

Setting

Landform: Drainageways on mountain slopes

Landform position (three-dimensional): Mountainflank

Down-slope shape: Linear, convex

Custom Soil Resource Report

Across-slope shape: Concave, convex

Parent material: Colluvium derived from limestone, sandstone, and shale and/or residuum weathered from limestone, sandstone, and shale

Typical profile

A1 - 0 to 10 inches: very cobbly loam

A12 - 10 to 16 inches: very gravelly silt loam

A2 - 16 to 20 inches: very gravelly silt loam

B21t - 20 to 26 inches: very gravelly silty clay loam

B22t - 26 to 44 inches: extremely gravelly clay loam

C1 - 44 to 72 inches: very gravelly silt loam

Properties and qualities

Slope: 30 to 60 percent

Depth to restrictive feature: More than 80 inches

Natural drainage class: Well drained

Capacity of the most limiting layer to transmit water (Ksat): Moderately high (0.20 to 0.60 in/hr)

Depth to water table: More than 80 inches

Frequency of flooding: None

Frequency of ponding: None

Available water storage in profile: Low (about 5.5 inches)

Interpretive groups

Land capability classification (irrigated): None specified

Land capability classification (nonirrigated): 7e

Hydrologic Soil Group: C

Ecological site: Mountain gravelly loam (oak) (R047XA410UT)

Description of Wallsburg

Setting

Landform: Ridges on mountain slopes

Landform position (two-dimensional): Summit

Landform position (three-dimensional): Mountainflank, interfluve, crest

Down-slope shape: Convex

Across-slope shape: Convex

Parent material: Colluvium and/or residuum

Typical profile

A1 - 0 to 5 inches: very cobbly loam

B1t - 5 to 9 inches: extremely cobbly silty clay loam

B2t - 9 to 17 inches: extremely cobbly silty clay

R - 17 to 27 inches: unweathered bedrock

Properties and qualities

Slope: 30 to 70 percent

Depth to restrictive feature: 12 to 20 inches to lithic bedrock

Natural drainage class: Well drained

Capacity of the most limiting layer to transmit water (Ksat): Very low to moderately high (0.00 to 0.20 in/hr)

Depth to water table: More than 80 inches

Frequency of flooding: None

Frequency of ponding: None

Available water storage in profile: Very low (about 1.4 inches)

Interpretive groups

Land capability classification (irrigated): None specified

Custom Soil Resource Report

Land capability classification (nonirrigated): 7s

Hydrologic Soil Group: D

Ecological site: Mountain shallow loam (mountain big sagebrush) (R047XA446UT)

Description of Horrocks

Setting

Landform: Mountain slopes

Landform position (three-dimensional): Mountainflank

Down-slope shape: Convex

Across-slope shape: Convex

Parent material: Colluvium and/or residuum

Typical profile

A11 - 0 to 10 inches: very cobbly loam

A12 - 10 to 14 inches: very cobbly clay loam

B2t - 14 to 29 inches: extremely cobbly clay loam

C - 29 to 40 inches: extremely cobbly loam

R - 40 to 50 inches: unweathered bedrock

Properties and qualities

Slope: 30 to 60 percent

Depth to restrictive feature: 12 to 20 inches to lithic bedrock

Natural drainage class: Well drained

Capacity of the most limiting layer to transmit water (Ksat): Very low to moderately high (0.00 to 0.60 in/hr)

Depth to water table: More than 80 inches

Frequency of flooding: None

Frequency of ponding: None

Salinity, maximum in profile: Nonsaline (0.0 to 2.0 mmhos/cm)

Available water storage in profile: Very low (about 1.8 inches)

Interpretive groups

Land capability classification (irrigated): None specified

Land capability classification (nonirrigated): 7s

Hydrologic Soil Group: D

Ecological site: Mountain stony loam (antelope bitterbrush) (R047XA456UT)

Minor Components

Rock outcrop

Percent of map unit: 5 percent

Harkers

Percent of map unit: 5 percent

HDF—Harkers-Dry Creek association, moderately steep

Map Unit Setting

National map unit symbol: j6hq
Elevation: 4,100 to 7,500 feet
Mean annual precipitation: 17 to 25 inches
Mean annual air temperature: 44 to 48 degrees F
Frost-free period: 80 to 150 days
Farmland classification: Not prime farmland

Map Unit Composition

Harkers and similar soils: 40 percent
Dry creek and similar soils: 25 percent
Copperton and similar soils: 25 percent
Minor components: 10 percent
Estimates are based on observations, descriptions, and transects of the mapunit.

Description of Harkers

Setting

Landform: Breaks on alluvial fans
Down-slope shape: Convex, concave
Across-slope shape: Linear, convex
Parent material: Colluvium derived from limestone, sandstone, and shale and/or residuum weathered from limestone, sandstone, and shale

Typical profile

A1 - 0 to 14 inches: loam
B1t - 14 to 19 inches: gravelly clay loam
B21t - 19 to 42 inches: gravelly clay
B22t - 42 to 58 inches: very gravelly clay
C1ca - 58 to 80 inches: very gravelly clay loam

Properties and qualities

Slope: 6 to 40 percent
Depth to restrictive feature: More than 80 inches
Natural drainage class: Well drained
Capacity of the most limiting layer to transmit water (Ksat): Moderately low to moderately high (0.06 to 0.20 in/hr)
Depth to water table: More than 80 inches
Frequency of flooding: None
Frequency of ponding: None
Available water storage in profile: Moderate (about 8.6 inches)

Interpretive groups

Land capability classification (irrigated): None specified
Land capability classification (nonirrigated): 6e

Custom Soil Resource Report

Hydrologic Soil Group: C

Ecological site: Mountain loam (oak) (R047XA432UT)

Description of Copperton

Setting

Landform: Breaks on alluvial fans

Down-slope shape: Concave, convex

Across-slope shape: Convex, linear

Parent material: Alluvium derived from limestone, sandstone, and shale

Typical profile

A11 - 0 to 6 inches: very gravelly loam

A12 - 6 to 13 inches: very cobbly loam

AC - 13 to 19 inches: very cobbly loam

C1ca - 19 to 42 inches: very gravelly loam

C2 - 42 to 60 inches: extremely gravelly loamy sand

Properties and qualities

Slope: 6 to 40 percent

Depth to restrictive feature: More than 80 inches

Natural drainage class: Well drained

*Capacity of the most limiting layer to transmit water (Ksat): Moderately high to high
(0.60 to 2.00 in/hr)*

Depth to water table: More than 80 inches

Frequency of flooding: None

Frequency of ponding: None

Calcium carbonate, maximum in profile: 60 percent

Salinity, maximum in profile: Nonsaline (0.0 to 2.0 mmhos/cm)

Sodium adsorption ratio, maximum in profile: 13.0

Available water storage in profile: Low (about 5.1 inches)

Interpretive groups

Land capability classification (irrigated): None specified

Land capability classification (nonirrigated): 7s

Hydrologic Soil Group: B

Ecological site: Upland gravelly loam (bonneville big sagebrush) (R028AY306UT)

Description of Dry Creek

Setting

Landform: Drainageways on alluvial fans

Down-slope shape: Linear, concave

Across-slope shape: Concave, convex

Parent material: Alluvium derived from limestone, sandstone, and shale

Typical profile

Ap - 0 to 6 inches: gravelly loam

A1 - 6 to 11 inches: gravelly loam

B1t - 11 to 15 inches: gravelly silty clay loam

B2t - 15 to 29 inches: gravelly silty clay

B3tca - 29 to 42 inches: gravelly silty clay loam

Cca - 42 to 60 inches: very gravelly silt loam

Properties and qualities

Slope: 15 to 30 percent

Depth to restrictive feature: More than 80 inches

Natural drainage class: Well drained

Custom Soil Resource Report

Capacity of the most limiting layer to transmit water (Ksat): Moderately low to moderately high (0.06 to 0.20 in/hr)

Depth to water table: More than 80 inches

Frequency of flooding: None

Frequency of ponding: None

Calcium carbonate, maximum in profile: 30 percent

Salinity, maximum in profile: Nonsaline (0.0 to 2.0 mmhos/cm)

Sodium adsorption ratio, maximum in profile: 30.0

Available water storage in profile: Moderate (about 8.1 inches)

Interpretive groups

Land capability classification (irrigated): None specified

Land capability classification (nonirrigated): 6e

Hydrologic Soil Group: C

Ecological site: Upland loam (bonneville big sagebrush) north (R028AY310UT)

Other vegetative classification: Upland Loam (Mountain Big Sagebrush)
(028AY310UT)

Minor Components

Dry creek

Percent of map unit: 5 percent

Harkers

Percent of map unit: 5 percent

HHF—Harkers soils, 6 to 40 percent slopes

Map Unit Setting

National map unit symbol: j6hs

Elevation: 5,500 to 7,500 feet

Mean annual precipitation: 20 to 25 inches

Mean annual air temperature: 44 to 46 degrees F

Frost-free period: 80 to 100 days

Farmland classification: Not prime farmland

Map Unit Composition

Harkers and similar soils: 45 percent

Harkers and similar soils: 45 percent

Minor components: 5 percent

Estimates are based on observations, descriptions, and transects of the mapunit.

Description of Harkers

Setting

Landform: Alluvial fans, mountain slopes

Down-slope shape: Concave

Across-slope shape: Convex

Custom Soil Resource Report

Parent material: Colluvium derived from limestone, sandstone, and shale and/or residuum weathered from limestone, sandstone, and shale

Typical profile

A1 - 0 to 14 inches: cobbly loam
B1t - 14 to 19 inches: gravelly clay loam
B21t - 19 to 42 inches: gravelly clay
B22t - 42 to 58 inches: very gravelly clay
C1ca - 58 to 80 inches: very gravelly clay loam

Properties and qualities

Slope: 6 to 40 percent
Depth to restrictive feature: More than 80 inches
Natural drainage class: Well drained
Capacity of the most limiting layer to transmit water (Ksat): Moderately low to moderately high (0.06 to 0.20 in/hr)
Depth to water table: More than 80 inches
Frequency of flooding: None
Frequency of ponding: None
Available water storage in profile: Moderate (about 8.2 inches)

Interpretive groups

Land capability classification (irrigated): None specified
Land capability classification (nonirrigated): 6e
Hydrologic Soil Group: C
Ecological site: Mountain loam (oak) (R047XA432UT)

Description of Harkers

Setting

Landform: Mountain slopes, alluvial fans
Down-slope shape: Concave
Across-slope shape: Convex
Parent material: Colluvium derived from limestone, sandstone, and shale and/or residuum weathered from limestone, sandstone, and shale

Typical profile

A1 - 0 to 14 inches: loam
B12 - 14 to 19 inches: gravelly clay loam
B21t - 19 to 42 inches: gravelly clay
B22t - 42 to 58 inches: very gravelly clay
C1ca - 58 to 80 inches: very gravelly clay loam

Properties and qualities

Slope: 10 to 40 percent
Depth to restrictive feature: More than 80 inches
Natural drainage class: Well drained
Capacity of the most limiting layer to transmit water (Ksat): Moderately low to moderately high (0.06 to 0.20 in/hr)
Depth to water table: More than 80 inches
Frequency of flooding: None
Frequency of ponding: None
Available water storage in profile: Moderate (about 8.6 inches)

Interpretive groups

Land capability classification (irrigated): None specified
Land capability classification (nonirrigated): 6e
Hydrologic Soil Group: C

Custom Soil Resource Report

Ecological site: Mountain loam (oak) (R047XA432UT)

Minor Components

Wallsburg

Percent of map unit: 5 percent

Landform: Mountain slopes

Ecological site: Mountain shallow loam (mountain big sagebrush) (R047XA446UT)

HNF—Henefer-Horrocks complex, 5 to 50 percent slopes

Map Unit Setting

National map unit symbol: j6hv

Elevation: 5,000 to 7,000 feet

Mean annual precipitation: 20 to 25 inches

Mean annual air temperature: 44 to 46 degrees F

Frost-free period: 80 to 100 days

Farmland classification: Not prime farmland

Map Unit Composition

Horrocks and similar soils: 30 percent

Henefer and similar soils: 30 percent

Henefer and similar soils: 30 percent

Minor components: 5 percent

Estimates are based on observations, descriptions, and transects of the mapunit.

Description of Henefer

Setting

Landform: Mountain slopes

Landform position (three-dimensional): Mountainflank

Down-slope shape: Convex

Across-slope shape: Convex

Parent material: Colluvium and/or residuum

Typical profile

A11&A12 - 0 to 10 inches: loam

B1 - 10 to 15 inches: clay loam

B21t - 15 to 25 inches: cobbly clay

B22t - 25 to 39 inches: very cobbly clay

B3t - 39 to 45 inches: very cobbly clay loam

C1 - 45 to 55 inches: very cobbly sandy clay loam

Properties and qualities

Slope: 10 to 40 percent

Depth to restrictive feature: More than 80 inches

Natural drainage class: Well drained

Capacity of the most limiting layer to transmit water (Ksat): Moderately low to moderately high (0.06 to 0.20 in/hr)

Depth to water table: More than 80 inches

Custom Soil Resource Report

Frequency of flooding: None
Frequency of ponding: None
Available water storage in profile: Moderate (about 7.0 inches)

Interpretive groups

Land capability classification (irrigated): None specified
Land capability classification (nonirrigated): 6e
Hydrologic Soil Group: C
Ecological site: Mountain loam (oak) (R047XA432UT)

Description of Henefer

Setting

Landform: Mountain slopes
Landform position (three-dimensional): Mountainflank
Down-slope shape: Convex
Across-slope shape: Convex
Parent material: Colluvium and/or residuum

Typical profile

A11&A12 - 0 to 10 inches: stony loam
B1 - 10 to 15 inches: clay loam
B21t - 15 to 25 inches: cobbly clay
B22t - 25 to 39 inches: very cobbly clay
B3t - 39 to 45 inches: very cobbly clay loam
C1 - 45 to 55 inches: very cobbly sandy clay loam

Properties and qualities

Slope: 10 to 40 percent
Depth to restrictive feature: More than 80 inches
Natural drainage class: Well drained
Capacity of the most limiting layer to transmit water (Ksat): Moderately low to moderately high (0.06 to 0.20 in/hr)
Depth to water table: More than 80 inches
Frequency of flooding: None
Frequency of ponding: None
Available water storage in profile: Moderate (about 6.7 inches)

Interpretive groups

Land capability classification (irrigated): None specified
Land capability classification (nonirrigated): 6e
Hydrologic Soil Group: C
Ecological site: Mountain loam (oak) (R047XA432UT)

Description of Horrocks

Setting

Landform: Mountain slopes
Landform position (three-dimensional): Mountainflank
Down-slope shape: Convex
Across-slope shape: Convex
Parent material: Colluvium and/or residuum

Typical profile

A11 - 0 to 10 inches: extremely stony loam
A12 - 10 to 14 inches: very cobbly clay loam
B2t - 14 to 29 inches: extremely cobbly clay loam
C - 29 to 40 inches: extremely cobbly loam

Custom Soil Resource Report

R - 40 to 50 inches: unweathered bedrock

Properties and qualities

Slope: 5 to 50 percent

Depth to restrictive feature: 12 to 20 inches to lithic bedrock

Natural drainage class: Well drained

Capacity of the most limiting layer to transmit water (Ksat): Very low to moderately high (0.00 to 0.60 in/hr)

Depth to water table: More than 80 inches

Frequency of flooding: None

Frequency of ponding: None

Salinity, maximum in profile: Nonsaline (0.0 to 2.0 mmhos/cm)

Available water storage in profile: Very low (about 1.8 inches)

Interpretive groups

Land capability classification (irrigated): None specified

Land capability classification (nonirrigated): 7s

Hydrologic Soil Group: D

Ecological site: Mountain stony loam (antelope bitterbrush) (R047XA456UT)

Minor Components

Little pole

Percent of map unit: 5 percent

HWF—Horrocks extremely stony loam, 5 to 50 percent slopes

Map Unit Setting

National map unit symbol: j6hw

Elevation: 5,000 to 7,000 feet

Mean annual precipitation: 20 to 25 inches

Mean annual air temperature: 44 to 46 degrees F

Frost-free period: 80 to 100 days

Farmland classification: Not prime farmland

Map Unit Composition

Horrocks and similar soils: 90 percent

Minor components: 10 percent

Estimates are based on observations, descriptions, and transects of the mapunit.

Description of Horrocks

Setting

Landform: Mountain slopes

Landform position (three-dimensional): Mountainflank

Down-slope shape: Convex

Across-slope shape: Convex

Parent material: Colluvium and/or residuum

Custom Soil Resource Report

Typical profile

A11 - 0 to 10 inches: extremely stony loam
A12 - 10 to 14 inches: very cobbly clay loam
B2t - 14 to 29 inches: extremely cobbly clay loam
C - 29 to 40 inches: extremely stony sandy loam
R - 40 to 50 inches: unweathered bedrock

Properties and qualities

Slope: 5 to 50 percent
Depth to restrictive feature: 12 to 20 inches to lithic bedrock
Natural drainage class: Well drained
Capacity of the most limiting layer to transmit water (Ksat): Very low to moderately high (0.00 to 0.60 in/hr)
Depth to water table: More than 80 inches
Frequency of flooding: None
Frequency of ponding: None
Salinity, maximum in profile: Nonsaline (0.0 to 2.0 mmhos/cm)
Available water storage in profile: Very low (about 1.8 inches)

Interpretive groups

Land capability classification (irrigated): None specified
Land capability classification (nonirrigated): 7s
Hydrologic Soil Group: D
Ecological site: Mountain stony loam (antelope bitterbrush) (R047XA456UT)

Minor Components

Henefer

Percent of map unit: 5 percent

Little pole

Percent of map unit: 5 percent

PT—Pits, mine

Map Unit Setting

National map unit symbol: nlq8
Elevation: 4,200 to 9,000 feet
Farmland classification: Not prime farmland

Map Unit Composition

Pits, mine: 100 percent
Estimates are based on observations, descriptions, and transects of the mapunit.

WAG—Wallsburg very cobbly loam, 30 to 70 percent slopes

Map Unit Setting

National map unit symbol: j6l8

Custom Soil Resource Report

Elevation: 5,500 to 7,500 feet
Mean annual precipitation: 20 to 25 inches
Mean annual air temperature: 44 to 46 degrees F
Frost-free period: 80 to 120 days
Farmland classification: Not prime farmland

Map Unit Composition

Wallsburg and similar soils: 100 percent
Estimates are based on observations, descriptions, and transects of the mapunit.

Description of Wallsburg

Setting

Landform: Mountain slopes
Landform position (three-dimensional): Mountainflank
Down-slope shape: Convex
Across-slope shape: Convex
Parent material: Colluvium and/or residuum

Typical profile

A1 - 0 to 5 inches: very cobbly loam
B1t - 5 to 9 inches: extremely cobbly silty clay loam
B2t - 9 to 17 inches: extremely cobbly silty clay
R - 17 to 27 inches: unweathered bedrock

Properties and qualities

Slope: 30 to 70 percent
Depth to restrictive feature: 12 to 20 inches to lithic bedrock
Natural drainage class: Well drained
Capacity of the most limiting layer to transmit water (Ksat): Very low to moderately high (0.00 to 0.20 in/hr)
Depth to water table: More than 80 inches
Frequency of flooding: None
Frequency of ponding: None
Available water storage in profile: Very low (about 1.4 inches)

Interpretive groups

Land capability classification (irrigated): None specified
Land capability classification (nonirrigated): 7s
Hydrologic Soil Group: D
Ecological site: Mountain shallow loam (mountain big sagebrush) (R047XA446UT)

References

American Association of State Highway and Transportation Officials (AASHTO). 2004. Standard specifications for transportation materials and methods of sampling and testing. 24th edition.

American Society for Testing and Materials (ASTM). 2005. Standard classification of soils for engineering purposes. ASTM Standard D2487-00.

Cowardin, L.M., V. Carter, F.C. Golet, and E.T. LaRoe. 1979. Classification of wetlands and deep-water habitats of the United States. U.S. Fish and Wildlife Service FWS/OBS-79/31.

Federal Register. July 13, 1994. Changes in hydric soils of the United States.

Federal Register. September 18, 2002. Hydric soils of the United States.

Hurt, G.W., and L.M. Vasilas, editors. Version 6.0, 2006. Field indicators of hydric soils in the United States.

National Research Council. 1995. Wetlands: Characteristics and boundaries.

Soil Survey Division Staff. 1993. Soil survey manual. Soil Conservation Service. U.S. Department of Agriculture Handbook 18. http://www.nrcs.usda.gov/wps/portal/nrcs/detail/national/soils/?cid=nrcs142p2_054262

Soil Survey Staff. 1999. Soil taxonomy: A basic system of soil classification for making and interpreting soil surveys. 2nd edition. Natural Resources Conservation Service, U.S. Department of Agriculture Handbook 436. http://www.nrcs.usda.gov/wps/portal/nrcs/detail/national/soils/?cid=nrcs142p2_053577

Soil Survey Staff. 2010. Keys to soil taxonomy. 11th edition. U.S. Department of Agriculture, Natural Resources Conservation Service. http://www.nrcs.usda.gov/wps/portal/nrcs/detail/national/soils/?cid=nrcs142p2_053580

Tiner, R.W., Jr. 1985. Wetlands of Delaware. U.S. Fish and Wildlife Service and Delaware Department of Natural Resources and Environmental Control, Wetlands Section.

United States Army Corps of Engineers, Environmental Laboratory. 1987. Corps of Engineers wetlands delineation manual. Waterways Experiment Station Technical Report Y-87-1.

United States Department of Agriculture, Natural Resources Conservation Service. National forestry manual. http://www.nrcs.usda.gov/wps/portal/nrcs/detail/soils/home/?cid=nrcs142p2_053374

United States Department of Agriculture, Natural Resources Conservation Service. National range and pasture handbook. <http://www.nrcs.usda.gov/wps/portal/nrcs/detail/national/landuse/rangepasture/?cid=stelprdb1043084>

Custom Soil Resource Report

United States Department of Agriculture, Natural Resources Conservation Service. National soil survey handbook, title 430-VI. http://www.nrcs.usda.gov/wps/portal/nrcs/detail/soils/scientists/?cid=nrcs142p2_054242

United States Department of Agriculture, Natural Resources Conservation Service. 2006. Land resource regions and major land resource areas of the United States, the Caribbean, and the Pacific Basin. U.S. Department of Agriculture Handbook 296. http://www.nrcs.usda.gov/wps/portal/nrcs/detail/national/soils/?cid=nrcs142p2_053624

United States Department of Agriculture, Soil Conservation Service. 1961. Land capability classification. U.S. Department of Agriculture Handbook 210. http://www.nrcs.usda.gov/Internet/FSE_DOCUMENTS/nrcs142p2_052290.pdf

APPENDIX C

Synthetic Liner Evaluation Technical Memorandum

East Waste Rock Extension HDPE Liner System Evaluation

PREPARED FOR: Zeb Kenyon/KUC
PREPARED BY: CH2M HILL
DATE: September 18, 2012

● Introduction

In August 2010, Kennecott Utah Copper (KUC) announced that it had begun evaluating the potential to extend the life of the Bingham Canyon Mine and operations to 2028. The extension, named the Cornerstone Project, would allow the mine to continue operation at current levels of copper production. The project involves pushing back the south wall of the mine about 1,000 feet and deepening the mine by about 300 feet to access additional ore resources. The Cornerstone Project will generate additional waste rock as part of the mining process. The East Waste Rock Extension (EWRE) consists of placing waste rock further east of the existing Keystone waste rock dumps.

One perceived benefit of the EWRE project is the opportunity to reclaim the historic, eastside dumps. These dumps will be reclaimed by grading the waste rock and covering it with an engineered cover. Subsequently, the reclaimed slopes will be re-vegetated. The cover will limit the infiltration of precipitation and oxygen to waste rock which may lead to the formation of low pH water with elevated concentrations of dissolved metals. KUC is investigating options to control the de minimus amount of seepage anticipated from waste rock that may seep into bedrock. As part of evaluating best available technologies for managing this water, this Technical Memorandum provides an evaluation of using an HDPE liner to capture any infiltration before it reaches the bedrock.

● Objectives

The objectives of this technical memorandum are as follows:

1. Evaluate regulatory based action leakage rates associated with high-density polyethylene (HDPE) liners for permitted facilities throughout the United States;
2. Evaluate the feasibility of using an HDPE liner at the bedrock/waste rock interface for the EWRE to reduce or prevent infiltration; and
3. Estimate order-of-magnitude construction costs for installing an HDPE liner under the EWRE footprint (+100/-50 percent accuracy).

● Liner Performance Comparison

Papers published by the United States Environmental Protection Agency (EPA) and the Geosynthetic Institute (GSI) are referenced in this comparison. Both the EPA and GSI have reviewed known facility performance and associated variables for water and leachate containment structures using HDPE liners to provide guidance regarding appropriate leakage rates. Although few examples of waste rock storage facilities or mining related facilities exist, a comparison can be drawn from the industry accepted action leakage rates (ALRs) for landfills, waste rock, and the few regulated facilities associated with mining

related leach water applications. Table 1 presents a comparison of ALR values and respective gpm flows relative to the 338 acres associated with the EWRE.

TABLE 1
Comparison of ALR for Lined Facilities

Facility Description/Type	Source	Action Leakage Rate (gal/acres-day)	Calculated EWRE ALR (gpm)
Landfills	EPA, 1993	100	25
Waste piles	EPA, 1992	100	25
In situ leach mines—General	Koerner & Koerner	1700	399
Metal laden seepage water—Alaska	Koerner & Koerner	480	112
In situ leach mines—South Dakota	Koerner & Koerner	1700	399
Leach collection systems—Utah EPA	Koerner & Koerner	200	46
“de minimum” leakage—Perfect liner	Koerner & Koerner	0.02 - 2.0	0.005 - 0.469

A review of the ALRs indicates a wide range of acceptable leakage rates for similar type and size facilities ranging from 25 to 399 gpm with respect to the 338 acres of the EWRE. The GSI review concluded that a liner that functions in a “perfect” manner leaks at a rate of 0.02 to 2.0 gallons/acre-day or 0.005 to 0.469 gpm when related to the EWRE footprint.

EPA guidance organizes landfills and waste rock into the same category. EPA review of the performance of these facilities concluded that a leakage rate below 100 gallons/acre-day, or approximately 25 gpm when related to the EWRE, is acceptable.

- **HDPE Liner Feasibility Evaluation**
- **Conceptual Design**

A basic conceptual liner system for the EWRE using HDPE to capture leachate (or WRCW) from waste rock material would consist of a gravel drainage system on top of the liner material. The liner would be supported by a clay layer and a subgrade foundation materials on top of the exposed bedrock. A gravel drainage system comprised of a minimum 1-foot-thick (minimum) pea-gravel layer would serve as an adequate drain conduit for a WRCW collection system. The gravel drainage layer would serve a secondary purpose of providing protection to the HDPE liner from the placement of the waste rock material. Due to the anticipated loading from the waste rock, a minimum 2.0-millimeter HDPE liner would be required.

Geosynthetic membranes would be required on top and below the drain rock layer. The membrane placed on top of the HDPE liner would provide protection during drain rock placement, and a second membrane placed on top of the drain rock would assist in maintaining the integrity of the drain rock layer during placement of waste rock.

Significant quantities of engineered fill composed of clay and foundation rock will be required to provide a smooth and stable bedding surface. This is needed to ensure proper WRCW drainage given the expected surface variability throughout the 338 acres of the EWRE. It is anticipated that an average thickness of at least 2 feet of engineered fill between the bedrock contact and the liner will be required to support the liner while providing clear drain paths for the WRCW to the collection system.

• Performance Analysis

As displayed in Table 1, the projected rate of leakage for the best possible performing HDPE system covering the 338 acres of the EWRE ranges from 0.005 to 0.469 gpm. Typical construction procedures that would result in the best possible liner involves an HDPE liner installed on a level surface with construction quality assurance (CQA) oversight to ensure proper welding. Such conditions would be required to minimize the number of holes contributing to leakage. However, due to the variability of the topography, size of area and the high loading on the HDPE liner from waste rock placement, the leakage rate has the potential to be much greater than that expected for a perfect landfill liner.

There are several challenges to consider when discussing the use of an HDPE liner over the EWRE foot print to prevent WRCW leakage from the lined facility:

- The variable topography will require extensive site preparation and large quantities of bedding material to minimize damage to the liner and promote adequate WRCW flow to a drainage collection system.
- Sloping areas on hillsides have the potential to create high “shear” zones in the liner that will likely result in significant liner tears.
- As HDPE liners age, they are subject to “stress cracking” and “brittle fractures,” even under ideal conditions. Given the high loads born by the HDPE liner from waste rock and the necessary sloping of the liner to facilitate WRCW drainage, the rates of “stress cracking” and “brittle fractures” will be amplified.
- The placement of waste rock and the manner in which it would be placed will place a significant load on the HDPE liner and will likely result in tears, punctures, and breaks in the welding.
- Anticipated WRCW seepage may become trapped beneath the liner and bypass the liner collection system. Concentrated flow will have a greater likelihood of percolating to bedrock.
- Rips and/or tears in the liner system cannot be detected or repaired once the waste rock has been placed.
- The liner would likely create a slip plane or unstable surface below the waste rock that would be subject to movement and a greater potential for dump failure.

In summary, there are multiple technical challenges to consider when installing an HDPE liner over the 338 acres of the EWRE that will require extensive engineering and CQA. It is likely that under the conditions listed above, the HDPE liner will eventually develop enough breaks, cracks, fractures, punctures, and tears leading to leakage rates exceeding most, if not all of the ALRs provided in Table 1 and above the seepage rate calculated for EWRE foundation materials.

Order-Of-Magnitude Construction Cost Estimate

Rough order-of-magnitude construction costs associated with installing the HDPE liner are estimated to be approximately \$120 million. Due to the large area, the highly variable nature of the topography, and the need to “smooth” out the receiving surface to ensure WRCW drainage, significant volumes of engineered fill will be required during the construction. The costs of installing the engineered fill exceed 50 percent of the overall cost.

The topography of the EWRE is variable and is assumed to similarly represent the underlying bedrock. Without fully understanding the nature of the underlying bedrock, the cost estimate represents a rough

order-of-magnitude cost estimate assuming the bedrock surface matches similarly that of the surface topography. Irregular surfaces and steep slopes may require additional earthwork and geomembranes that will further add to construction costs.

● Conclusions

In conclusion, the HDPE liner installation has failure risks as detailed above that would most likely result in seepage rates greater than those ALRs displayed in Table 1. In addition, the hydraulic conductivity of the underlying bedrock provides a low permeability barrier that will perform as good or better than an engineered liner to prevent infiltration of WRCW into the underlying bedrock. The natural bedrock topography also provides a surface contact ideal for directing WRCW towards the collection system. Last, the benefits of limiting infiltration through the use of an engineered store and release cover, as described in Attachment 2, Groundwater Discharge Control Plan, far exceed those of installing an HDPE liner below the EWRE footprint. Therefore, the installation of an HDPE liner is not recommended for the EWRE project.

● References

- Lupo, J.F. and K.M. Morrison. 2005. *Innovative Geosynthetic Liner Design Approaches and Construction in the Mining Industry*. ASCE Geotechnical Special Publications.
- Murray, G.B., E.A. McBean, and J.F. Sykes. 1995. *Estimation of Leakage Rates through Flexible Membrane Liners*. GWMR 148.
- United States Environmental Protection Agency (EPA). 1987. *Quantification of Leak Rates through Holes in Landfill Liners* (Project Summary); K.W. Brown, J.C. Thomas, R.L. Lytton, P. Payawickrama, and S.C. Bahrt. EPA/600/S2-87/062. November 1987.
- EPA. 1993. *LDCRS Flow from Double Lined Landfills and Surface Impoundments* (Project Summary); Rudolph Bonaparte & Beth A. Gross. EPA/600/SR-93/070. June 1993.
- EPA. 1992. *Action Leakage Rates for Leak Detection Systems, Supplemental Background Document for the Final Double Liners and Leak Detection Systems Rule for Hazardous Waste Landfills, Waste Piles and Surface Impoundments*. US EPA Office of Solid Waste, EPA-530-R-92-004. January 1992
- Koerner, R.M. and Koerner, J.R. 2009. *Survey of U.S. State Regulations on Allowable Leakage Rates In Liquid Impoundments and Wastewater Ponds* (GRI White Paper #15). Geosynthetic Institute.

Attachment 2: Groundwater Discharge Control Plan

South Waste Rock Reclamation

Groundwater Discharge Permit UGW350010 Modification

Kennecott Utah Copper LLC

November 2014

Kennecott Water Quality Group

THIS PAGE INTENTIONALLY LEFT BLANK

Contents

Section	Page
1.0 Introduction	1-1
2.0 Existing and Planned System.....	2-1
2.1 Existing System	2-6
2.2 Proposed System	2-6
2.2.1 Waste Rock Cover Design	2-7
2.2.2 Storm Water Control on Dump Face	2-7
2.2.3 Storm Water Detention Basins	2-9
2.2.4 Water Collection System	2-16
3.0 Monitoring and Inspection Methods.....	3-1
3.1 Operational Monitoring Sites	3-1
3.2 Operational Reporting and Inspections	3-1
4.0 Summary of Controls	4-1
5.0 References.....	5-1

Tables

2-1	Summary of Drainage Basin Inputs and Results for the 100-Year, 24-Hour Design Event
2-2	Estimated Peak Storm Volumes
2-3	Existing and New Cut-off Walls
2-4	Approximate Cut-off Wall Dimensions
3-1	Operational Sites
3-2	Failure Scenarios

Figures

2-1	South Waste Rock Reclamation (SWRR) Area
2-2	Average Sulfate Concentrations in SWRR Area
2-3	Average Concentrations of TDS in the SWRR Area
2-4	Detention Basin Outlet Structure
2-5	Detention Basin Weir Structure
2-6	Typical Cut-off Wall
3-1	Operational Monitoring Points

THIS PAGE INTENTIONALLY LEFT BLANK

Acronyms and Abbreviations

ARD	acid rock drainage
BAT	Best Available Technology
BCM	Brigham Canyon Mine
cm/s	centimeter(s) per second
ECS	Eastside Collection System
HDPE	high-density polyethylene
KUC	Kennecott Utah Copper LLC
mm	millimeter(s)
PSD	particle size distribution
psi	pound(s) per square inch
TDS	total dissolved solids
SWRR	South Waste Rock Reclamation
UDOGM	Utah Division of Oil, Gas and Mining
UDWQ	Utah Department of Environmental Quality, Division of Water Quality
WRCW	waste rock contact water
WWDPS	Wastewater Disposal Pump Station

THIS PAGE INTENTIONALLY LEFT BLANK

1.0 Introduction

The permitted facility includes the Eastside Collection System (ECS) associated with waste rock at the Kennecott Utah Copper LLC (KUC) Bingham Canyon Mine (BCM). The BCM operations are located in the Oquirrh Mountains approximately 18 miles southwest of Salt Lake City, Utah. This mine produces copper and other metals that are currently extracted using an open-pit method of mining. Open-pit operations have been conducted at this site for over 110 years.

The ECS currently operates under Groundwater Discharge Permit UGW350010, issued by the Utah Department of Environmental Quality, Division of Water Quality (UDWQ). Groundwater Discharge Permit UGW350010 was first issued in June 1999 and has been renewed on a regular basis approximately every 5 years. The most-recent renewal was March 23, 2010 (UDWQ, 2010) and the next renewal will be March 2015.

The waste rock associated with this mining operation has been placed adjacent to the open pit on the slopes of the Oquirrh Mountains. The waste rock disposal areas consist of over 5 billion tons of waste rock. The waste rock consists of low concentrations of sulfide mineralization and trace metals in an intrusive host rock, limestone, and quartzite.

This permit modification is applicable to the south waste rock area between the Olsen drainage (southern extent) to the Yosemite drainage (northern extent). KUC is applying for a permit modification to address the South Waste Rock Reclamation (SWRR) project. This Groundwater Discharge Control Plan has been prepared to fulfill Part C, Section 9, of the permit modification application. The plan demonstrates how potential impacts to groundwater resources as a result of placing waste rock on the new footprint will be minimized by maintaining Best Available Technology (BAT) at current standards, and how impacts will be further minimized through the following:

- 1) Installation of a store-and-release cover
- 2) Improvement of storm water controls on the reclaimed waste rock

The remainder of this plan is organized as follows:

- Section 2.0—Existing and Planned Systems
- Section 3.0—Monitoring and Inspection Methods
- Section 4.0—Summary of Controls

THIS PAGE INTENTIONALLY LEFT BLANK

2.0 Existing and Planned System

Between the years of 1994 and 1996, a collection system was installed to collect mine leach water reporting to the toe of the waste rock dumps at the Bingham Canyon Mine. Upon the cessation of active leaching in 2000, the system remained in place to capture waste rock contact water (WRCW) that results from storm water infiltration through the waste rock. Monitoring wells are installed down gradient of the capture system to demonstrate the effectiveness of the system to prevent WRCW from entering the aquifer through compliance with the Utah Ground Water Quality Protection Program. Figure 2-1 depicts the location of the existing cut-off walls and the proposed cut-off walls as well as the new detention basin locations and ultimate areas of contribution post reclamation in relation to the existing south dump.

The current cut-off wall collection system has demonstrated satisfactory performance from 1998 to the present time, as indicated by the compliance monitoring well network. Collection system performance and water quality data are reported to UDWQ quarterly through compliance monitoring reports and, more-extensively, in annual reports. Figure 2-2 presents average sulfate concentrations in down gradient monitoring wells in the SWRR area from 1998 to 2014. As shown in the figure, sulfate concentrations have decreased or remained constant since the installation of the cut-off wall collection system. Figure 2-3 shows concentrations of total dissolved solids (TDS) have also decreased or remained constant during the same time period. A more-detailed discussion of monitoring well sampling results is included in Attachment 1, Supplemental Hydrogeologic Report.

THIS PAGE INTENTIONALLY LEFT BLANK

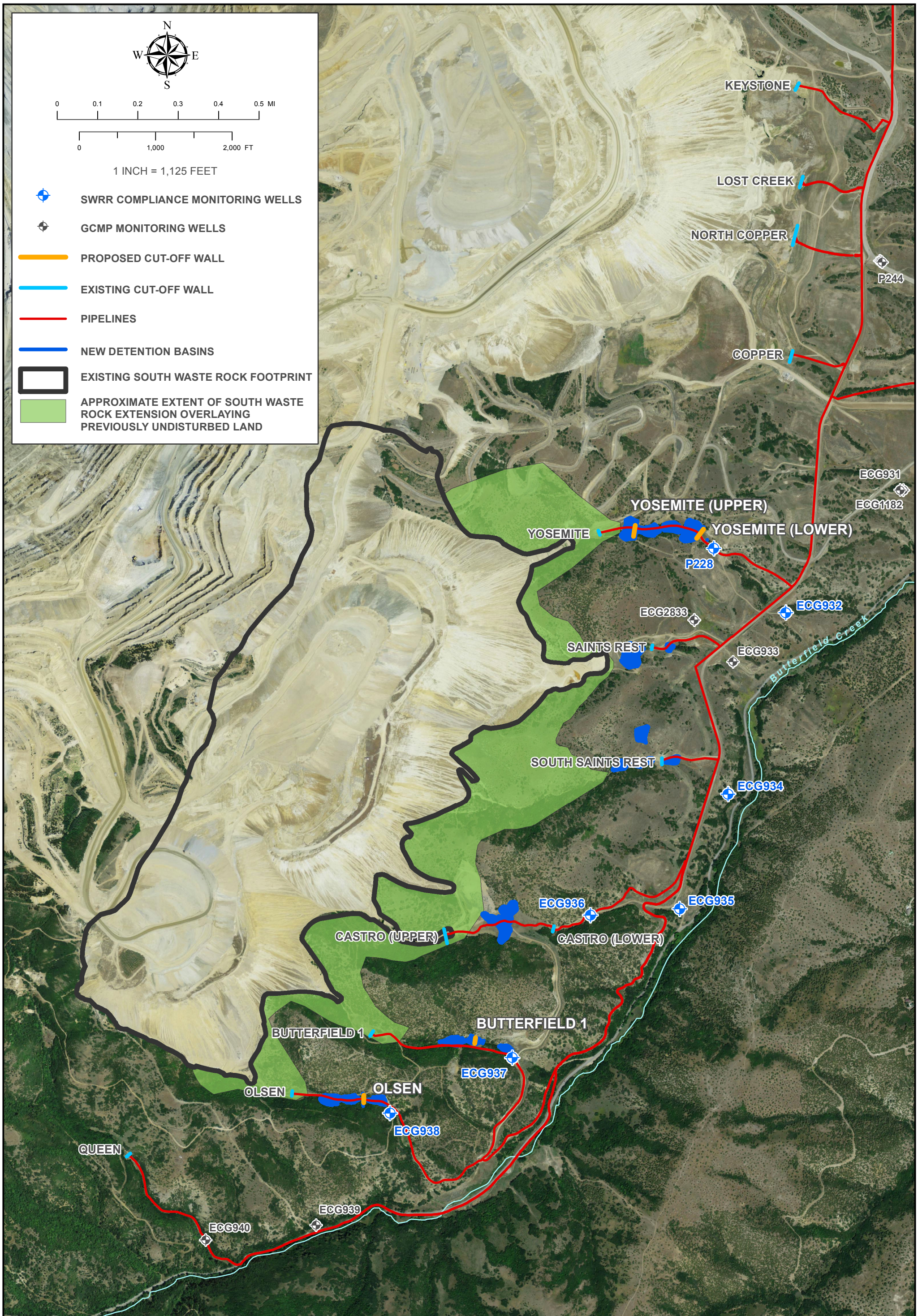

FIGURE 2-2
Average Sulfate Concentrations in SWRR Area

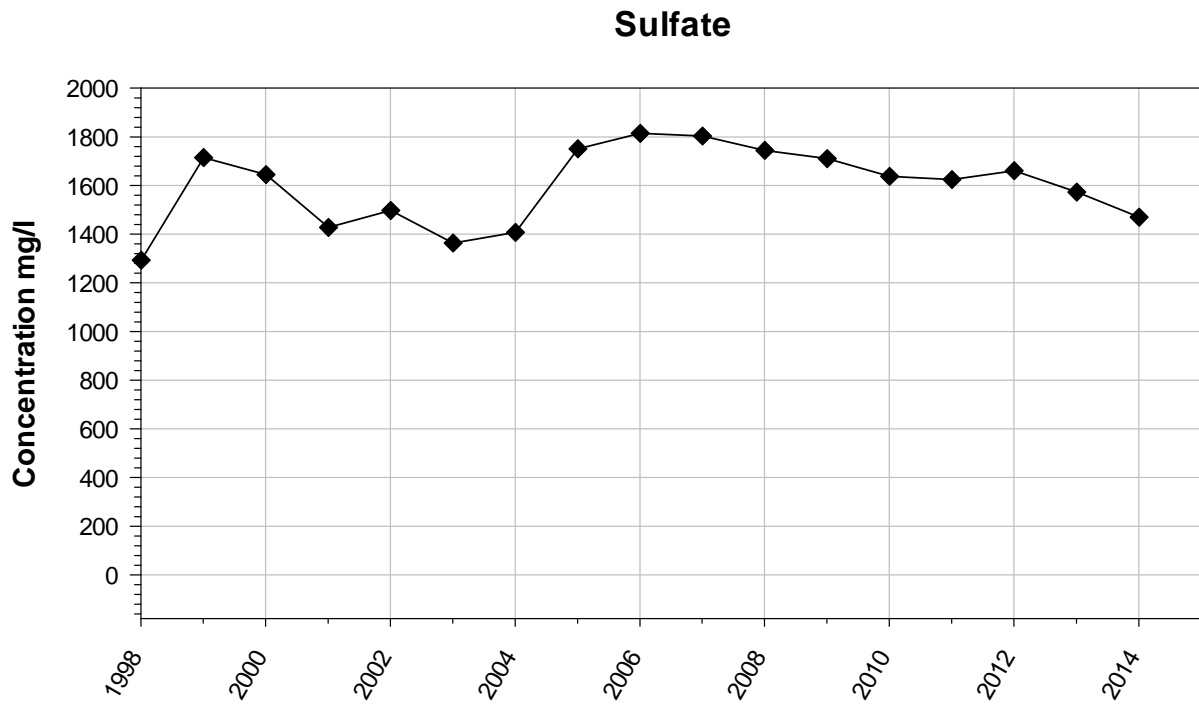
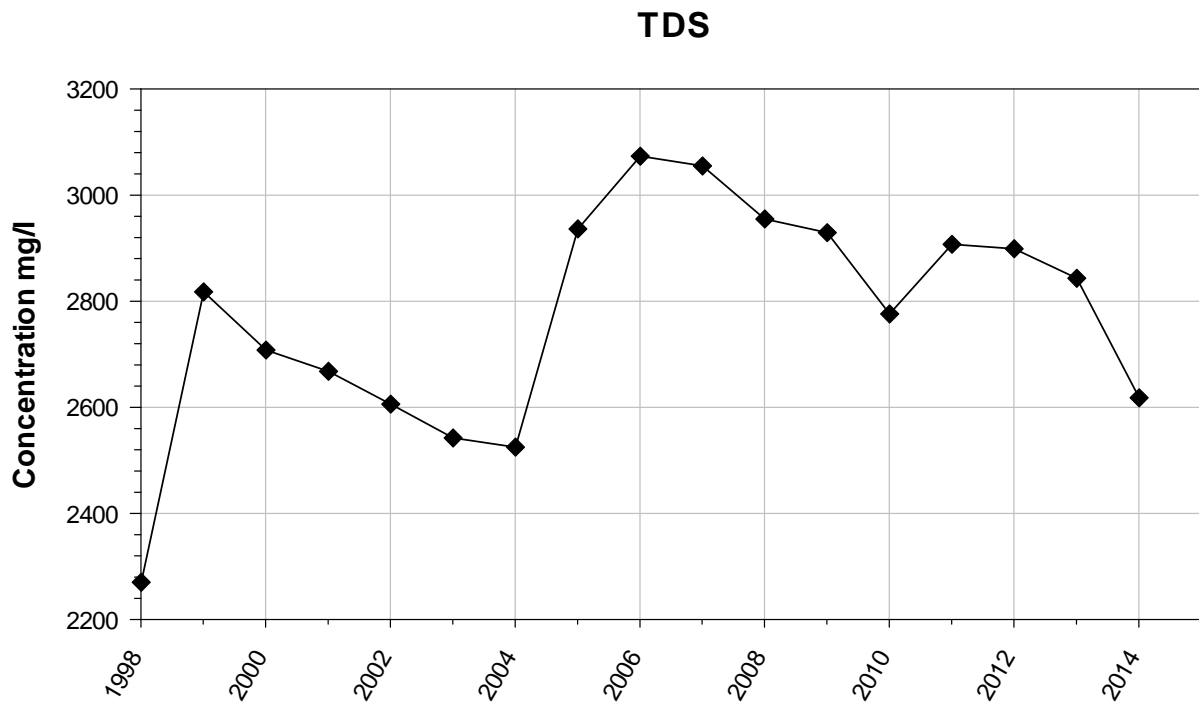

FIGURE 2-3
Average Concentrations of TDS in the SWRR Area



2.1 Existing System

The WRCW from the existing waste rock is currently captured by gravity flow and cut-off walls located near the toe of the waste rock in each drainage basin. The water is then gravity fed to a collection system. The water from the SWRR area commingles with other ECS flows to an existing Precipitation Plant where dissolved copper is extracted. Details of the current system are described in the following paragraphs. The cut-off walls and conveyance piping for the existing SWRR collection system is shown in Figure 2-1.

Storm water, and the WRCW emerging from the toe of the waste rock dumps is collected in a series of French drains, collector pipes and cut-off wall installations, with one installation located in each of the principal drainages down gradient from the toe of the waste rock. These installations intercept surface and alluvial flow. A typical WRCW and storm water collection system installation contains the following elements:

- Earthen storm water detention basins collect storm water immediately down gradient from the toe of the waste rock and capture sediment before entering the pipelines.
- Piping, where practical, captures mine-impacted water close to the dump toe and conveys it to the cut-off wall.
- A concrete containment wall, or cut-off wall, installed into the underlying bedrock directs the flow of storm water and WRCW from the basins into the collection system. Perforated pipes and gravel parallel to the cut-off wall and direct subsurface waters to the collection system piping.
- Additional earthen sediment detention basins down gradient of the cut-off wall, if needed to adequately manage a 100-year, 24-hour design storm event within the collection system.

High-density polyethylene (HDPE) pipe conveys WRCW and storm water collected in the individual basins to the main collection system pipe.

The collection pipeline and its ancillary structures capture and convey the WRCW from the collection facilities to the Precipitation Plant, and overflow to the Bingham Canyon Large Reservoir, which has two HDPE liners underlain by a clay liner. The Bingham Canyon Large Reservoir facility is under a separate groundwater discharge permit (UGW350006).

2.2 Proposed System

The existing waste rock dumps have non-vegetated angle-of-repose slopes too steep to be reclaimed. Deliberate and systematic placement of waste rock in front of the existing dumps will allow for relaxed slopes that can be reclaimed, and will also allow for the addition of storm water management systems. Where waste rock is placed to the east and southeast, three existing cut-off walls will need to be relocated within Yosemite (includes 2 cut-off walls), Butterfield 1 and Olsen drainages where the new footprint will cover or disrupt the existing cut-off wall(s) and collection system. Waste rock placement to the downstream of the existing dumps will allow for the opportunity to implement the following changes:

- Overall reclaimed waste rock slopes at a ratio of 2.5 horizontal feet to 1 vertical foot
- A vegetated waste rock cover designed to minimize erosion, sustain vegetation, and reduce infiltration and subsequent WRCW generation
- Surface water management systems to direct and control storm water flows off the catch benches and reclaimed dump faces, reducing infiltration and the potential for erosion

- A new collection system design consisting of the following:
 - Detention basins within each drainage designed to collectively manage a 100-year, 24-hour storm event
 - Four new relocated cut-off walls

The aforementioned design upgrades are discussed in more detail in this permit modification attachment.

Before waste rock is placed within the project area, native areas containing previously undisturbed vegetation will be excavated to bedrock.

The system as a whole will work similarly to the current system in that WRCW and storm water flows will gravity drain and require no pumping. The WRCW flows will gravity drain from the toe of the reclaimed slopes and into the ECS.

2.2.1 Waste Rock Cover Design

The reclamation approach for the SWRR includes placing a vegetated cover, atop the relaxed slope waste rock. The cover is a vegetated soil cap designed to reduce infiltration of meteoric precipitation to the underlying waste rock. The cover is important to the groundwater discharge permit in that by minimizing meteoric water from entering the waste rock, minimization of WRCW reporting at the toe of the dump can also be achieved. The vegetation will also reduce surface erosion which has the ability to overwhelm the basin and wall collection system by filling basins and plugging outlet piping.

The cover is one component of the larger reclamation process. A brief and simplified description of the reclamation sequence is provided as follows:

- Strip and stockpile growth media from the footprint of the SWRR area. Where the footprint is over native and relatively undisturbed ground, the media will be stripped to bedrock while segregating the GM if possible (primarily associated with topsoil and containing a seed bank of native vegetation) from the GC and CL units, which will be essentially homogenized through the salvage, stockpile, and final placement process. Where the footprint is over slopes atop historic waste rock, only the material that will support vegetation will be salvaged.
- Place waste rock by end dumping with appropriate step backs so that each lift may be relaxed to a 2.5:1 slope. The slope will be cross-ripped parallel to the toe and crest to provide a surface that will anchor the cover to the underlying waste rock.
- Place cover material along the crest or top of the relaxed slope, doze material to desired thickness, and cross rip parallel to the toe and crest. Cross-ripping of the slope will be executed to limit erosion potential on slopes by minimizing the potential for concentrated flow paths and bring fine material to the surface resulting in microhabitats to encourage plant establishment. The cross-rips also provide water catchment and storage for vegetation.
- Apply soil amendments as needed and plant with species of seed mix and seedlings approved by the Utah Division of Oil, Gas and Mining (UDOGM).

2.2.2 Storm Water Control on Dump Face

After reclamation of the waste rock and installation of cover materials, a storm water management system will be installed to control and direct storm water from the benches of the reclaimed slopes. The storm water will be directed from the benches to storm water detention basins located upgradient of the cut-off walls. This is important to the groundwater discharge permit because a robust storm water

and sediment collection system will minimize infiltration into waste rock and subsequent ARD generation associated with WRCW. The storm water management system will also limit sediment from entering the WRCW collection system, minimizing the chance of sediment buildup and plugging of the pipelines.

The purpose of the storm water design is to control and capture storm water and minimize contact with the waste rock to minimize generation of WRCW. Damage to the areas at the base of the waste rock from high-velocity flows will be prevented by the use of energy dissipation structures.

The primary design objectives are to capture surface water runoff, manage runoff to prevent erosion of surface soils, and minimize subsequent sediment delivery to the collection system. Slope length and slope steepness are critical factors in erosion potential and determine the velocity of the runoff. Long, continuous slopes allow runoff to build up momentum with resulting high-velocity flows that concentrate to produce rills and gullies. Since the predominant erosion process is the transportation of soil particles by flowing water, diversion benches, and riprap-lined channels (downdrain channels) have been designed to create velocity breaks and counteract erosional effects of unarmored surfaces.

To prevent erosive velocities from occurring on the long dump slopes, the slopes will be bisected with diversion benches at regular intervals. The benches will be placed approximately every 200 to 250 vertical feet. The benches will reduce the velocity of runoff flowing down the slope by shortening the distance that runoff can flow directly downhill. In addition to slowing runoff velocity, the diversion benches will provide a place for small amounts of sediment to settle out. The diversion benches will be back-sloped at 2 percent toward the dump face with channels constructed at the bench-slope interface to convey storm water to the riprap-lined downdrains.

The diversion benches will concentrate and direct surface flow reporting to the bench from the reclaimed dump face. These channels will be lined with compacted benign waste rock blended to form a low-permeability barrier for storm water, thus reducing the potential for surface water infiltration and the subsequent formation of WRCW. To prevent erosion, the diversion bench channels will also be armored with coarse, angular rock.

Differential settlement along the benches is anticipated, causing low points in the diversion bench channel and possible ponding of water. To prevent overtopping of the diversion bench and erosion of the slope below, a berm will be constructed along the outside edge of the diversion bench. Flow collected by the diversion benches and conveyed in the diversion bench channels will be directed to downdrains.

Riprap-lined downdrain channels have been designed to carry concentrated runoff collected by the diversion benches down the waste rock slopes without causing erosion. These channels will deliver runoff to the collection system and are intended to serve as permanent waterways that have been designed, shaped, and lined to provide for safe conveyance of surface runoff.

Flow velocity will be minimized by lining the channels with rip-rap. The riprap-lined channels will be wide enough so that runoff flows will be fully contained. The channels have sufficient capacity to pass the peak flow from a 100-year, 24-hour SCS type II storm. The rip-rap has been sized to be stable and resistant to erosion at the design peak flow. Well-graded rip-rap forms a dense, flexible, self-healing cover that will adapt well to uneven surfaces.

At locations where the flow transitions from the diversion bench channel into the downdrain, it is critical to prevent erosion of the downdrain channel, diversion bench channel, and diversion bench berm. To prevent the potential for flows to bypass around the rip-rap on the benches, flow is diverted laterally along the benches after each downdrain. This lateral flow is then collected into a transition structure

graded so stormwater flows cross the bench and pass through culverts arranged in the safety berm connecting flow to the next down drain.

To prevent scour at the outlet of rip-rap-lined channels, flow transition structures are provided to dissipate the flow's high energy and reduce the flow velocity. Flow transition structures include rip-rap aprons and rip-rap energy dissipation basins.

2.2.3 Storm Water Detention Basins

The storm water detention basin design includes detention basins in all SWRR drainages. The size of each detention basin was determined based on the estimated peak flow rates from storm water modeling based on a 100-year, 24-hour storm event and the planned, reclaimed site topography. At a minimum, the storage provided in the detention basins will be sufficient to route the estimated peak storm volume into the collection system. Modeling details are described as follows.

A model capable of both hydrologic and hydraulic modeling was selected to simulate storm water flows from the SWRR. The model HydroCAD 10.0 (HydroCAD Software Solutions LLC, 2011) was selected to predict and evaluate the storm water flow rates. These results were then routed into Storm and Sanitary Analysis (AutoDesk, 2014) to determine the hydraulics of the conveyance system for both storm water and WRCW flows. This approach results in a comprehensive model for dynamic modeling of storm water, sanitary, and river systems to simulate natural rainfall-runoff processes and the performance of engineered systems used to convey those flows.

Several parameters were required for the hydrologic piece of the model. They include the 100-year, 24-hour storm curve data and the basin information such as area, time of concentration, and elevation data for each of the sub-basins identified. All model runs used a curve number of 68 for reclaimed and natural surfaces, and 80 for disturbed surfaces (i.e., waste rock). Final design uses a CN value of 68 for the entire reclaimed and natural surface. This information is shown in Table 2-1.

TABLE 2-1
Detention Basin Summary - 100-year, 24-hour Event

Watershed	Total Area (acres)	NOAA 24 hr 100-yr (in)	Runoff (cfs)	Basin							
				Basin ID	Inflow (cfs)	Outflow (cfs)	Depth (ft)	Volume (ac.-ft)	Outlet Orifice (in)	Outlet Length (feet)	100-yr Overflow (cfs)
Olsen	129	3	71	1.2	70.85	13.07	17	1.55	10	87	44.64
				1.1	57.71	9.84	15	1.33	8	75	25.22
				Cutoff Wall	35.06	9.69	-	-	12	-	25.31
				11	25.31	11.70	12	1.05	8	95	-
Butterfield	68	3	37	2.2	37.35	5.81	16	2.32	6	150	-
				2.1	5.81	5.65	15	0.92	8	88	-
				Cutoff Wall	5.65	4.33	-	-	10	-	1.31
				21	1.31	1.08	12	1.01	6	262	-
Castro	280	3.45	199.47	3.3	199.47	12.57	14	11.52	10	71	1.81
				3.2	14.38	11.78	18	4.51	10	79	-
				3.1	11.78	11.74	18	3.53	14	614	-
				Cutoff Wall	11.74	11.74	-	-	14	-	-
So. Saints Rest	97	3.45	61.73	4.1	31.26	7.83	12	1.32	6	70	-
				4.4	30.47	6.97	16	1.29	6	55	1.43
				4.3	8.40	5.08	8	0.30	8	45	3.27
				4.2	15.91	5.83	9	0.20	8	45	10.03
				Cutoff Wall	15.86	7.22	10	0.53	12	-	8.37
Saints Rest	84	3.45	36.9	41	8.37	6.31	10	0.38	12	50	-
				5.1	36.9	7.42	12	2.07	8	65	4.94
				Cutoff Wall	12.36	5.82	-	-	12	-	6.55
Yosemite	50	3.45	102.9	51	6.55	5.31	10	0.33	12	50	-
				6.4 UCOW	102.9	10.33	12	1.88	10	1000	92.57
				6.3	92.57	13.36	17	2.84	10	131	11.82
				6.2	25.18	11.53	20	2.57	10	104	-
				6.1 LCOW	11.53	10.71	12	1.32	12	200	-

Results of the model were used to size detention basins designed to contain the peak storm volume. Table 2-2 shows contributing acreages and peak storm volumes used to size the storm water detention basins.

TABLE 2-2
Estimated 100-year, 24-hour Peak Storm Volumes

Drainage and Basins	Estimated Peak Storm	
	Contributing Watershed Area (acres)	Volume (acre-feet)
Yosemite	189	13.7
Saints Rest	84	6.1
South Saints Rest	97	4.0
Castro	280	29.8
Butterfield 1	77	4.9
Olsen	129	9.4
Total	856	68.0

Detention basins were designed based upon the topographic characteristics specific to each drainage. These basins were permitted through UDWQ prior to this modification and are on file with the division. Typical design elements are provided in Figures 2-4 and 2-5. The design varies by basin, and positioned in each of the drainages in order to maximize the storage and minimize the heights of the

embankments. Spillway berms are generally kept under an impounded height of 15 feet and discharge from the basin is controlled by the grated outlet structure and outlet pipe orifice size. In the event the outlet structure plugs, a rip-rap spillway provides an emergency overflow or are otherwise overwhelmed with storm water.

The detention basins are sized to accommodate the peak storm volumes to attenuate the peak flows. The detention basins are all below 20 acre-feet and are classified low risk under the Utah Dam Safety regulations. The detention basins are slightly oversized to accommodate sediment buildup and will require periodic cleaning to maintain the desired storage volume. The drain pipes from the bottom of the detention basins through the primary outflow structure are sized to provide drainage of the basins within 24 hours. Piping between the cut-off walls and the downstream collection system has been sized to accept the entire peak flow from the design storm by gravity drainage into the piping.

Storm water detention basins generally will be located below the toe of the waste rock and above the cut-off walls unless field conditions indicate additional capacity is needed to gain the 100-year, 24-hour storm peak.

THIS PAGE INTENTIONALLY LEFT BLANK

FIGURE 2-4
 Detention Basin Outlet Structure

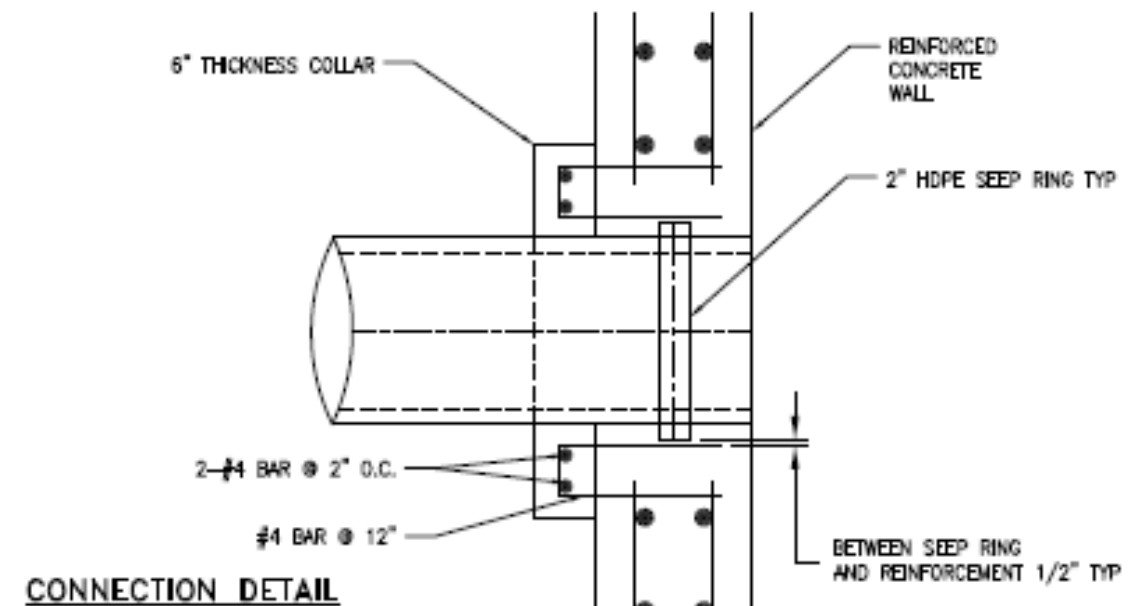
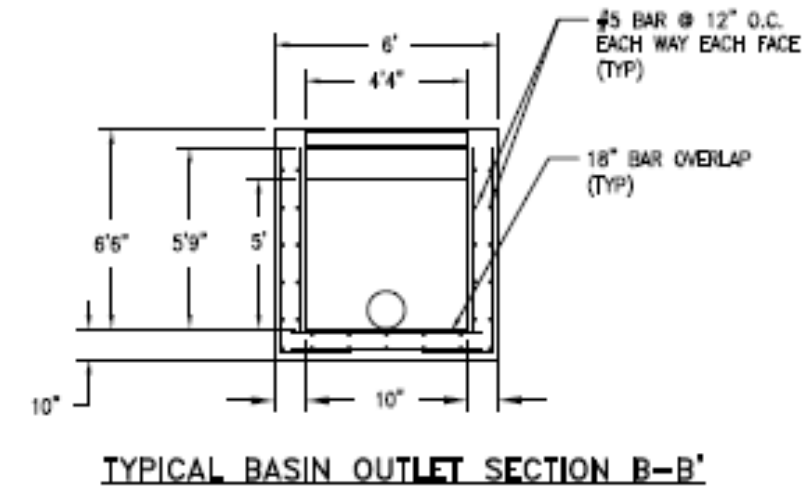
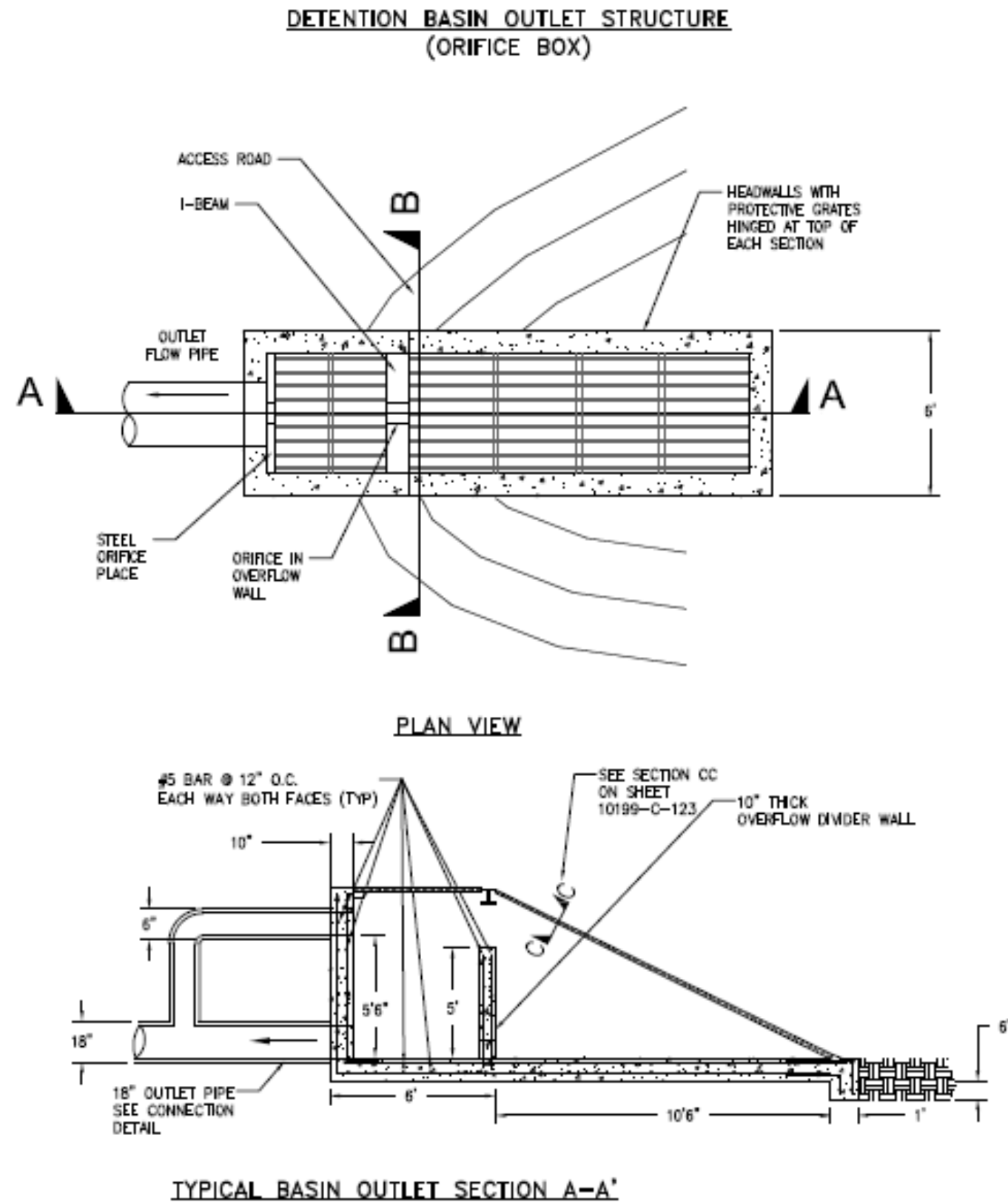

- NOTES:
1. USE STRUCTURAL CARBON STEEL FOR ALL STRUCTURAL STEEL CONFORMANT TO AASHTO DESIGNATION M270 GRADE 36 (ASTM A 709, GRADE 36).
 2. HOT-DIP GALVANIZE ALL STRUCTURAL STEEL AFTER FABRICATION IN ACCORDANCE WITH AASHTO DESIGNATION M11 (ASTM A 123).
 3. STRUCTURAL STEEL: $F_y = 36,000 \text{ psi}$
 4. COVER ALL REINFORCING STEEL BY AT LEAST 3" AGAINST EARTH.

MODIFIED OUTLET FOR USE AT SOUTH & NORTH BENCH BASIN EXCEPTION:

DIMENSIONS:
 OVERFLOW DIVIDER WALL=6.5'
 TOTAL OUTLET STRUCTURE HEIGHT=8'-10"
 OUTLET ORIFICE=6"
 DIVIDER WALL ORIFICE=6"

THIS PAGE INTENTIONALLY LEFT BLANK

FIGURE 2-5
 Detention Basin Weir Structure

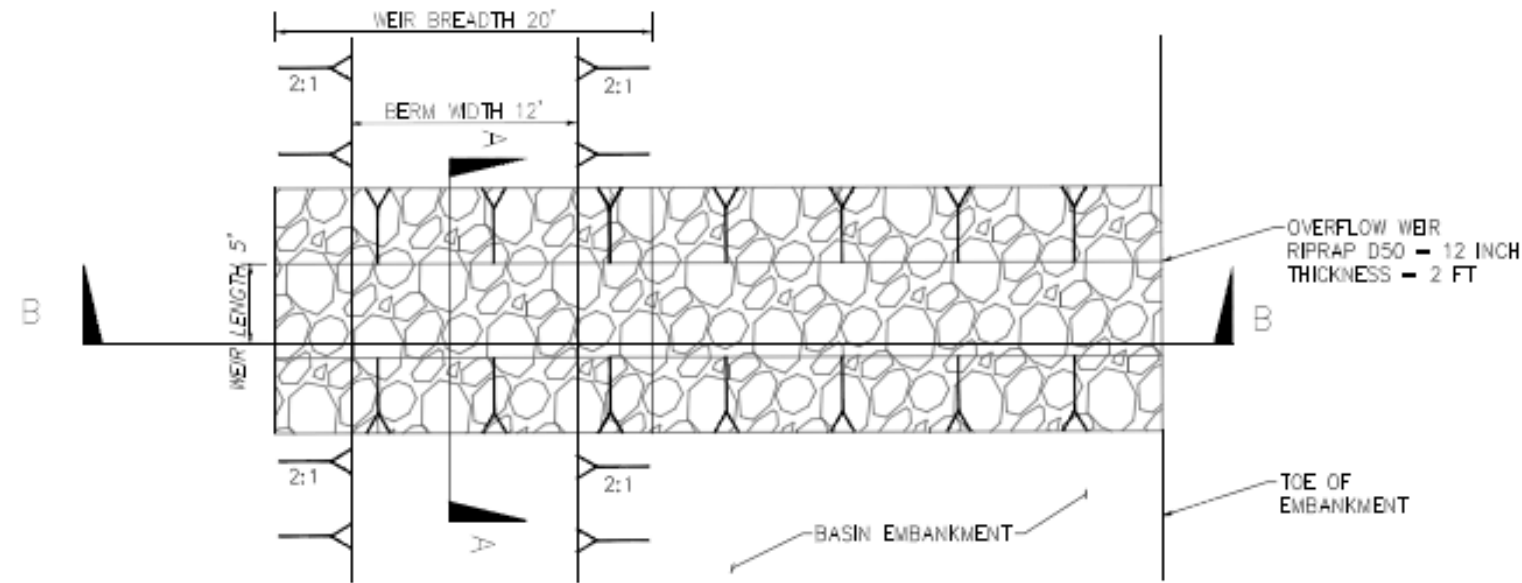

DETENTION BASIN OVERFLOW WEIR STRUCTURE
 PLAN VIEW

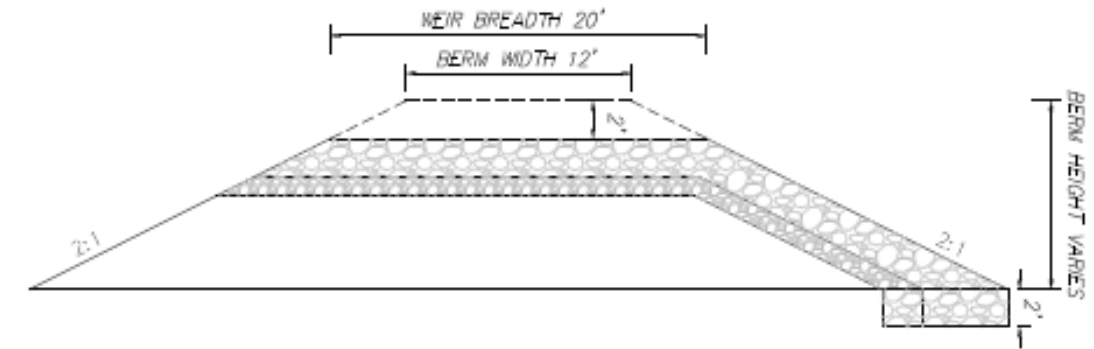

DETENTION BASIN WEIR STRUCTURE
 SECTION BB

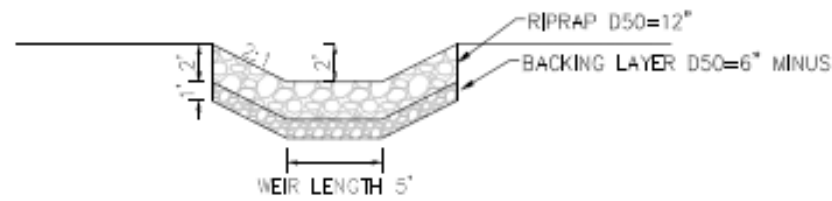

DETENTION BASIN WEIR STRUCTURE
 SECTION AA

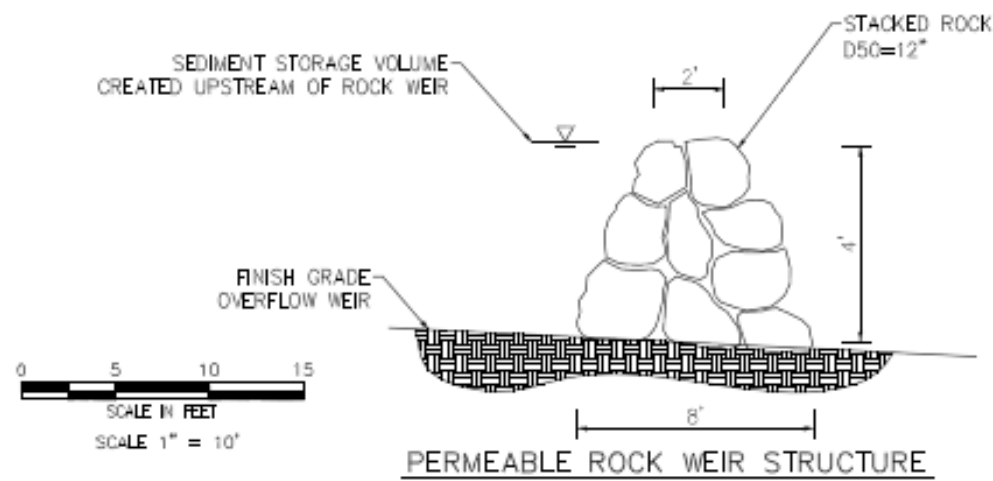

NOTES
 1. EMBANKMENT CONSTRUCTION SUBJECT
 TO BE APPROVED BY RTKC REPRESENTATIVE.

THIS PAGE INTENTIONALLY LEFT BLANK

2.2.4 Water Collection System

The new system improves upon the existing system through more-efficient capture of storm water by placing drains on the relaxed waste rock and increasing the storm water capacity. An illustration of the proposed new collection system is provided in Figure 2-5, and details regarding the various components of the modifications to the water collection system are provided in the following sections.

Key design criteria for the relocated new cut-off walls included the following:

- The new system will be designed to capture surface and alluvial water upgradient of the cut-off walls.
- Storm water will be conveyed along with existing WRCW to the existing Precipitation Plant and onward to the WWDPs.
- The cut-off wall locations will accommodate gravity flows from the cut-off walls to the down gradient collection system piping.
- The system is designed for a 24-hour, 100-year storm event.
- New walls will be located upgradient from known significant increases in alluvial thickness or where bedrock dips steeply to the east.

The primary WRCW collection system employs the use of gravity flow to convey storm and WRCW to the cut-off walls. More detail on the capture systems is included in later sections of this document.

Construction Sequencing

Construction sequencing will be coordinated to continue WRCW capture while the new system is built and commissioned. The main collection system piping will not be changed. Construction sequencing will generally be conducted in the following manner:

1. The cut-off walls will be constructed in the three drainages where cut-off walls will be relocated to intercept surface and alluvial flows and will be built into the low permeability bedrock as indicated by field conditions.
2. The connections will be made between the WRCW piping, cut-off walls and the existing downstream collection piping.
3. Cut-off walls to be covered by the SWRR will be breached or fitted with hard piping that connects with downstream collection system piping.

The cut-off walls will be constructed in the order in which they will be impacted by waste rock placement. The current plan for waste rock placement starts at Yosemite and moves south toward Olsen.

The exact location of the cut-off walls will be determined in the field based on actual depth to bedrock and the low-permeable surface required for optimum capture of mine-impacted water. Extensive field investigations have been conducted to establish the location of the cut-off walls. However, the actual bedrock topography may differ from what is currently shown on the design drawings. Figure 2-1 illustrates the potential extent of waste rock coverage based on the field installation of the new relocated cut-off walls or existing cut-off walls. Cut-off wall locations and dimensions shown in Figure 2-1 and in the design drawings will be subject to "field fit" based on actual bedrock topography.

The current design drawings show the locations of the storm water detention basins.

2.2.4.1 Primary Collection System

The system is designed to intercept WRCW moving along the bedrock contact as it reports directly from the toe of the waste rock. Field investigations conducted in the project area have determined that low permeability bedrock is present at the base of the alluvium beneath the proposed waste rock placement. The hydraulic conductivity of waste rock is several orders of magnitude higher than the underlying Paleozoic and volcanic bedrocks which have geometric mean hydraulic conductivities of 5×10^{-5} centimeters per second (cm/s) (KUC, 1994). Additional hydrogeological information is located in Attachment 1, Supplemental Hydrogeological Report.

The existing waste rock contains seeps that do not always coincide with drainage bottoms or waste rock toes. Due to the land surface gradient, any seep not in a drainage bottom will gravity report to the drainage bottom.

2.2.4.2 Cut-off Walls

The cut-off walls are designed as the capture system for alluvial groundwater. Similar to the existing system, the four new relocated cut-off walls will be located and installed into bedrock for structural support and to enhance capture effectiveness. A French drain will run parallel to the base of each cut-off wall along the surface of the bedrock to capture any WRCW. Figure 2-1 shows the approximate locations of the cut-off walls, and Figure 2-6 shows a typical cut-off wall in cross-section.

FIGURE 2-6
 Typical Cut-off Wall

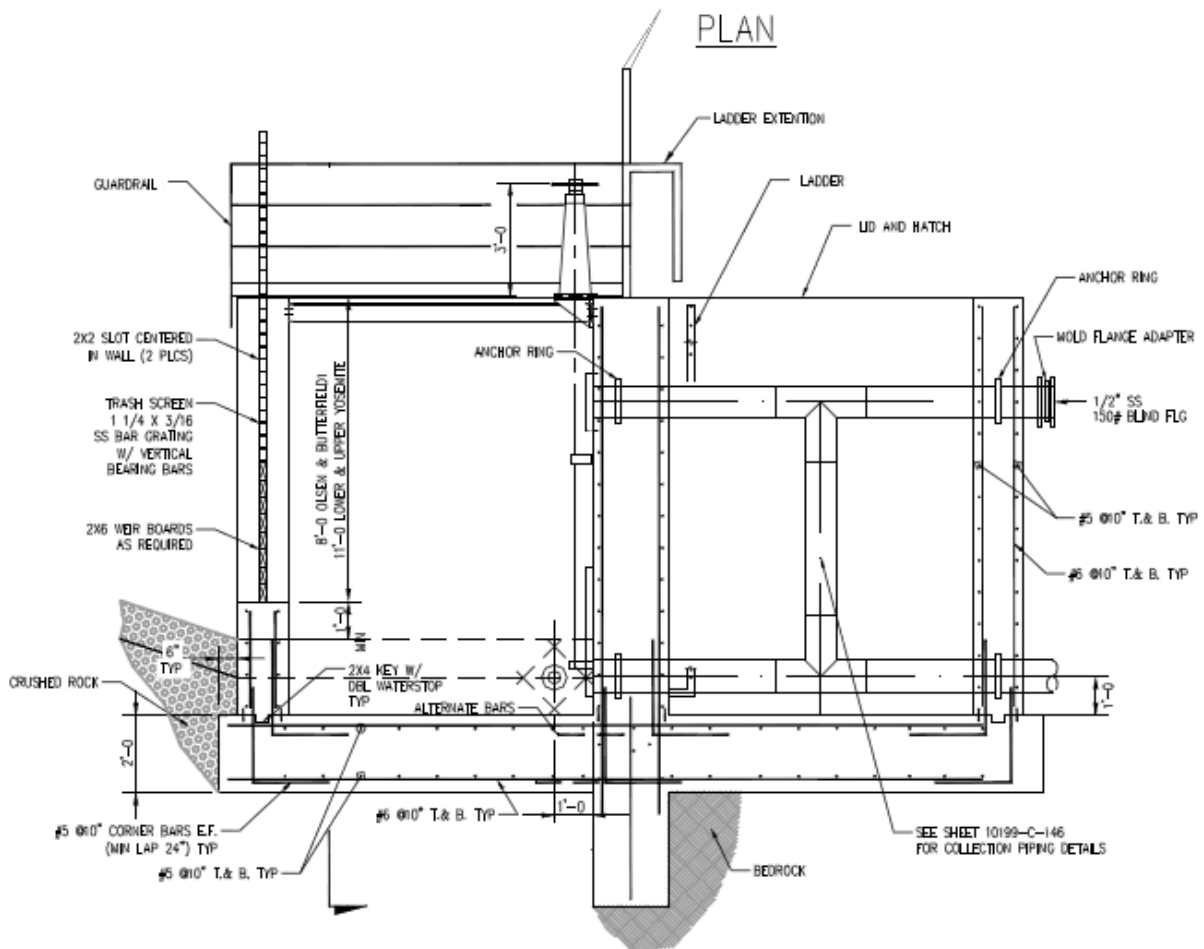

Based on bedrock topography and available geography for water capture, Yosemite drainage will have two walls built to replace the current single wall. Table 2-3 shows the existing and proposed new cut-off walls.

TABLE 2-3
Existing and New Cut-off Walls

Existing Cut-off Wall	New Cut-off Wall (relocated)
Yosemite	Build Upper Yosemite Build Lower Yosemite
Saints Rest	Use existing wall
South Saints Rest	Use existing wall
Castro	Use existing lower wall
Butterfield 1	Build wall
Olsen	Build wall

Field efforts to site the relocated new cut-off wall locations consisting of test pit excavations, sonic drilling, and site surveys were performed in 2014 to determine the depth to bedrock at the proposed cut-off wall locations. Field logs are included in the South End Dump Reclamation Project Cut-Off Wall Field Investigation (CH2M HILL, 2014).

Storm water from the detention basins will pass through the cut-off wall into the common collection system where it will be conveyed ultimately to the WWDPs.

The estimated size of each wall was determined based on bedrock and surface topography and will be modified during construction based on field conditions. Approximate cut-off wall dimensions are shown in Table 2-4. Cut-off walls will be constructed with concrete and rebar.

TABLE 2-4
Approximate Cut-off Wall Dimensions

Proposed Cut-off Wall (relocated)	Approximate Dimensions (feet) (Maximum Depth × Overall Length)
Yosemite (upper)	16 × 110
Yosemite (lower)	16 × 93
Butterfield 1	13 × 48
Olsen	13 × 79

2.2.4.3 Water Conveyance Piping

The collection system down gradient of the cut-off walls includes an existing pipeline to receive the storm water and WRCW from the new system. This existing pipeline gravity drains ultimately to the existing WWDPs.

3.0 Monitoring and Inspection Methods

Monitoring is described in detail in the Compliance Monitoring Plan (Attachment 3). Compliance wells are currently sampled to determine the compliance of the cut-off wall system. No changes in approach to the compliance monitoring strategy are proposed as part of this permit modification.

3.1 Operational Monitoring Sites

New wells will be added as described in Attachment 3, Compliance Monitoring Plan, and operational monitoring sites will be replaced as shown on Table 3-1 and Figure 3-1 (shown at the end of this section). Three changes are proposed to the operational sites shown on Table 3-1. Water from existing seeps covered by the new waste rock footprint will be collected by the new toe drain system. Seeps outside of the SWRR footprint and down gradient of the collection system will remain unchanged.

New operational monitoring sites will have formatted names and numbers in accordance with the current KUC Groundwater Characterization Monitoring Plan. Well replacement is described in more detail in Attachment 3, Compliance Monitoring Plan.

TABLE 3-1
 Operational Monitoring Sites

Sample ID	NAD 83		Existing Cut-off Wall	New Cut-off Wall (relocated)
	Latitude (dd)	Longitude (dd)		
ECPXXXX	40.5137981	-112.1152069	Yosemite	Yosemite (lower)
ECPXXXX	40.5138637	-112.1134159		Yosemite (upper)
ECP2614	40.5096559	-112.1126471	Saints Rest	No change
ECP2612	40.505598	-112.1121861	South Saints Rest	No change
ECP2606	40.4993765	-112.1171746	Castro	No change
ECP2605	40.4956904	-112.125681	Butterfield 1	Butterfield 1
ECP2603	40.4935162	-112.1294315	Olsen	Olsen

3.2 Operational Reporting and Inspections

Monitoring data for operational sites including cut-off walls, seeps, and informational wells will be submitted to UDWQ in an annual report to be provided by March 31 of each year, consistent with the existing groundwater discharge permit.

Quarterly inspections are currently performed on the collection system to verify proper operation and to confirm the system continues to operate as designed. The quarterly inspections will continue for the new system with no changes to compliance points.

Additionally, the entire system will continue to receive regular maintenance and repair. Quarterly inspections of the collection system including the detention basins, cut-off walls, flumes, and pipelines will continue to be performed. Repairs and regular maintenance will be maintained to keep the system's robust design fully operational.

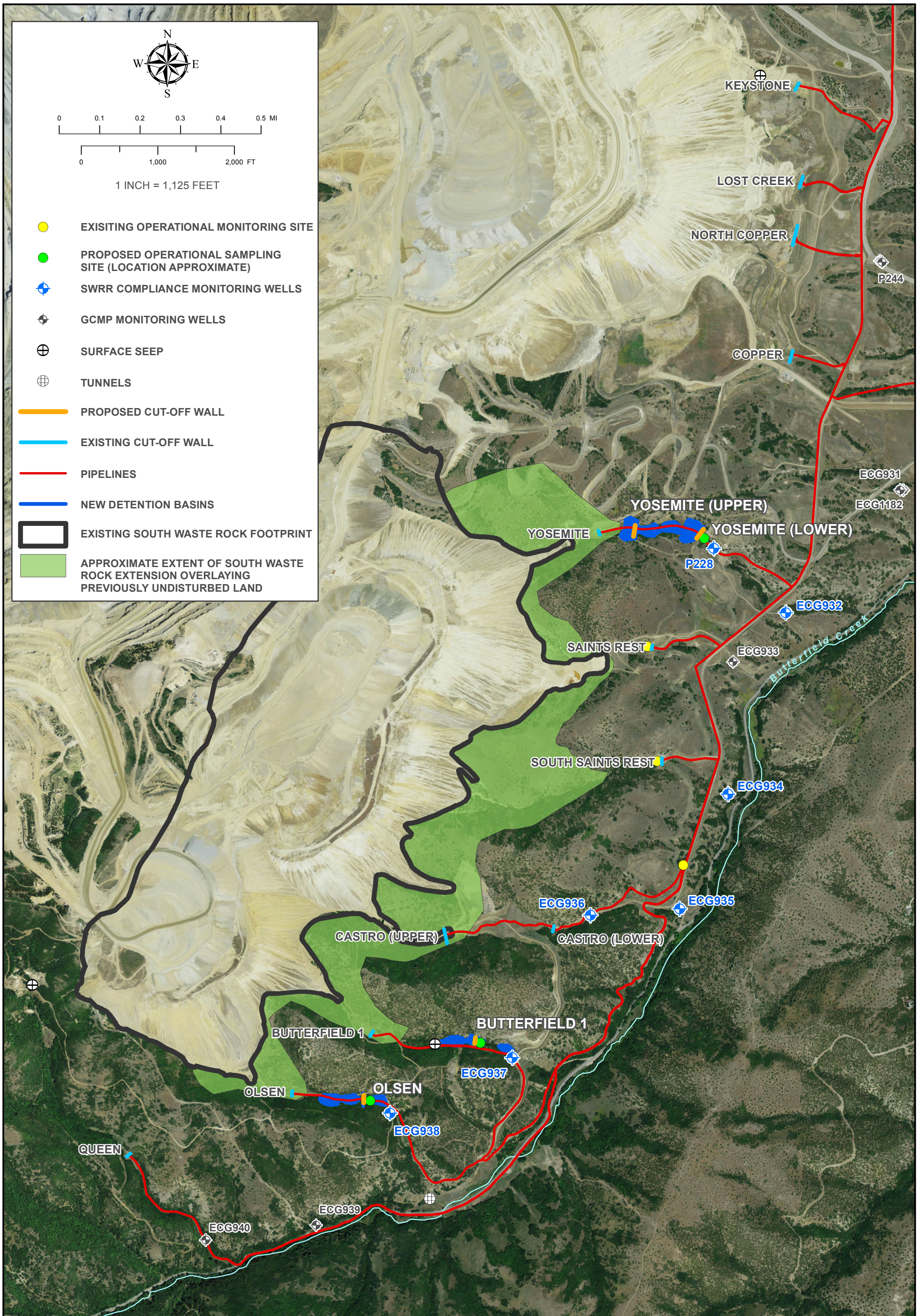

N
W E
S

0 0.1 0.2 0.3 0.4 0.5 MI
0 1,000 2,000 FT
1 INCH = 1,125 FEET

- EXISTING OPERATIONAL MONITORING SITE
- PROPOSED OPERATIONAL SAMPLING SITE (LOCATION APPROXIMATE)
- ⊕ SWRR COMPLIANCE MONITORING WELLS
- ⊕ GCMP MONITORING WELLS
- ⊕ SURFACE SEEP
- ⊕ TUNNELS
- PROPOSED CUT-OFF WALL
- EXISTING CUT-OFF WALL
- PIPELINES
- NEW DETENTION BASINS
- EXISTING SOUTH WASTE ROCK FOOTPRINT
- APPROXIMATE EXTENT OF SOUTH WASTE ROCK EXTENSION OVERLAYING PREVIOUSLY UNDISTURBED LAND

4.0 Summary of Controls

The 1994 permit application (KUC, 1994) summarized potential losses of WRCW to the environment. The improved systems will further minimize potential losses with the following:

- Reduction of net percolation and resulting reduction in drainage as a result of the vegetated cover
- Additional storm water handling capacity
- Storm water and drainage management
- Reclaimed waste rock slopes

Quarterly operations and maintenance will continue to be performed to maintain the system. Down gradient monitoring wells will be sampled to continue monitoring water quality in each of the drainages.

The entire new water management and collection system has been designed with redundancy, as applicable, to minimize the potential for release of WRCW to the environment.

THIS PAGE INTENTIONALLY LEFT BLANK

5.0 References

CH2M HILL. 2014. South End Dump Reclamation Project Cut-off Wall Field, September.

Kennecott Utah Copper LLC (KUC). 1994. *Eastside Collection Monitoring System, Groundwater Discharge Permit Application Revision 1*. June.

Utah Department of Environment Quality, Division of Water Quality (UDWQ). 2010. *Groundwater Discharge Permit #UGW350010*. March.

THIS PAGE INTENTIONALLY LEFT BLANK

Attachment 3: Compliance Monitoring Plan

South Waste Rock Reclamation

Groundwater Discharge Permit UGW350010 Modification

Kennecott Utah Copper LLC

November 2014

Kennecott Water Quality Group

THIS PAGE INTENTIONALLY LEFT BLANK

Contents

Section	Page
1.0 Introduction	1-1
1.1 Purpose	1-1
1.2 Context.....	1-1
1.3 Monitoring Strategy Overview	1-2
2.0 Operational Monitoring.....	2-1
2.1 Source Monitoring	2-1
2.1.1 Tunnels.....	2-2
2.1.2 Seeps.....	2-2
2.1.3 Vadose Zone Monitoring	2-3
2.1.4 Inspections.....	2-3
3.0 Groundwater Monitoring Program	3-1
4.0 Other Specific Requirements	3-2
5.0 References.....	5-1

Tables

2-1	Operational Sampling Sites
2-2	Tunnels within the SWRR Project Area
2-3	Seeps Near the SWRR Project Area

Figures

1-1	SWRR Compliance Monitoring Network
2-1	Operational Monitoring Points

Appendices

A	Existing SWRR Compliance Monitoring Wells and Status After the Proposed Modification
B	SWRR Compliance Well Permit Limits (units of mg/L and pH standard units)

THIS PAGE INTENTIONALLY LEFT BLANK

Acronyms and Abbreviations

BAT	Best Available Technology
BCM	Brigham Canyon Mine
cm/s	centimeter(s) per second
ECS	Eastside Collection System
HDPE	high-density polyethylene
KUC	Kennecott Utah Copper LLC
mm	millimeter(s)
PSD	particle size distribution
psi	pound(s) per square inch
TDS	total dissolved solids
SWRR	South Waste Rock Reclamation
UDOGM	Utah Division of Oil, Gas and Mining
UDWQ	Utah Department of Environmental Quality, Division of Water Quality
WRCW	waste rock contact water
WWDPS	Wastewater Disposal Pump Station

THIS PAGE INTENTIONALLY LEFT BLANK

1.0 Introduction

The permitted facility includes the Eastside Collection System (ECS) associated with waste rock at the Kennecott Utah Copper LLC (KUC) Bingham Canyon Mine (BCM). The BCM operations are located in the Oquirrh Mountains approximately 18 miles southwest of Salt Lake City, Utah. This mine produces copper and other metals that are currently extracted using an open-pit method of mining. Open-pit operations have been conducted at this site for over 100 years.

The ECS, which includes the South Waste Rock Reclamation (SWRR) area, currently operates under Groundwater Discharge Permit UGW350010, issued by the Utah Department of Environmental Quality, Division of Water Quality (UDWQ). Groundwater Discharge Permit UGW350010 was first issued in June 1999 and has been renewed on a regular basis approximately every 5 years. The most recent renewal was March 23, 2010 (UDWQ, 2010).

Waste rock associated with mining operation has been placed adjacent to the open-pit on the slopes of the Oquirrh Mountains. The waste rock disposal areas consist of over 5 billion tons of waste rock. The waste rock consists of low concentrations of sulfide mineralization and trace metals in an intrusive host rock, limestone, and quartzite.

This permit modification is applicable to the south and southeast facing waste rock dumps between the Olsen drainage (southern extent) to the Yosemite drainage (northern extent). KUC is applying for a permit modification to address the SWRR project.

1.1 Purpose

In accordance with Utah Administrative Code R317-6-6.3 I&L, a Compliance Monitoring Plan is required to demonstrate that the best available technology (BAT) used is functioning adequately to protect area groundwater quality. The plan will demonstrate how compliance with groundwater protection limits for the SWRR water collection system will be achieved. This plan is consistent with Appendix A of the *Groundwater Discharge Permit No. UGW350010* (Utah Department of Environmental Quality, Division of Water Quality [DWQ], 2010) and will address changes to the existing monitoring system as a result of modifications to the relocation of cut-off walls and collection system to accommodate an expanded reclaimed waste rock footprint. For more details regarding the proposed water collection system modifications, see Attachment 2 of the SWRR Groundwater Discharge Permit Modification Application.

1.2 Context

Proposed changes to the compliance monitoring plan are specific to the SWRR project area. The SWRR area includes all drainages from Yosemite drainage at the northern extent of the project area to the Olsen drainage at the southern extent of the project. Drainages outside of this area and their associated compliance monitoring locations will not be impacted by the SWRR and will be maintained as required to comply with the existing permit. The SWRR project area is illustrated in Figure 1-1.

Elements of the SWRR pertaining to site hydrogeology, hydro-geochemistry, and water quality are discussed in Attachment 1 of the SWRR Groundwater Discharge Permit Modification Application. In addition, KUC has an existing groundwater monitoring plan that is described in the *Groundwater Characterization and Monitoring Plan* (GCMP) (KUC, 2014). The GCMP outlines the procedures and methods for the collection, analysis, and reporting of groundwater monitoring data.

This Compliance Monitoring Plan for the SWRR Water Collection System includes the following:

- Monitoring strategy
- Description of the operational monitoring program
- Description of the compliance monitoring program

The plan outlines the groundwater and operational monitoring associated with the permit and the protection of the principal aquifer of the southwestern Jordan Valley.

1.3 Monitoring Strategy Overview

The BAT inspection, maintenance, operational monitoring, and groundwater compliance monitoring will be performed as specified in the existing groundwater discharge permit for the Mine and ECS. Compliance monitoring is divided into two categories, operational compliance and groundwater compliance. Operational monitoring consists of inspections to verify the collection system is operating as designed and that it continues to be properly maintained. In addition, operational sampling points associated with the collection system will be evaluated. Groundwater compliance monitoring consists of sampling a network of wells down gradient of the collection system to verify the collection system is operating as designed and that waste rock contact water (WRCW) is being managed in accordance with the groundwater discharge permit. An illustration of the operational monitoring sites and groundwater monitoring locations is provided in Figure 1-1.

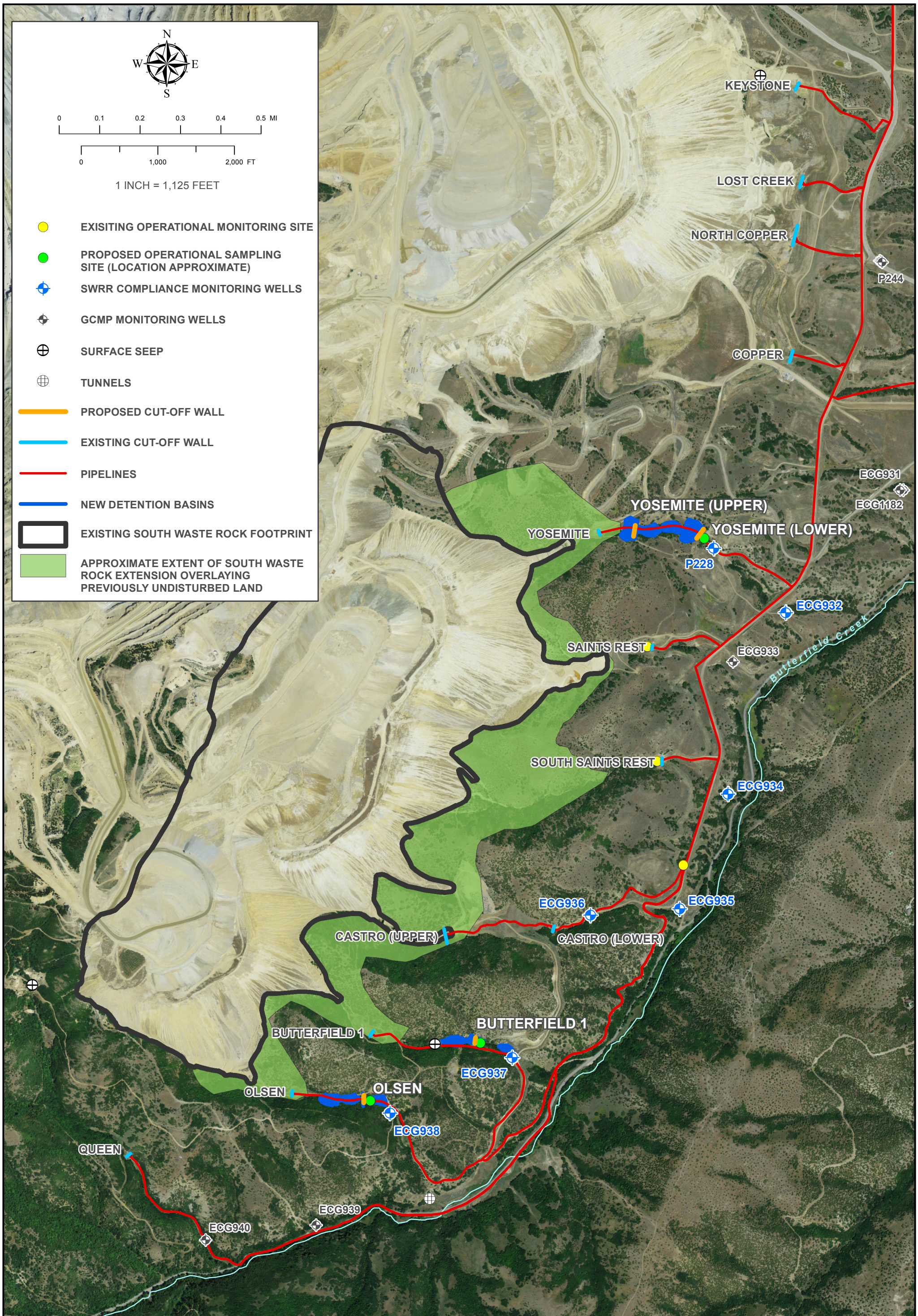

N
W E
S

0 0.1 0.2 0.3 0.4 0.5 MI
0 1,000 2,000 FT
1 INCH = 1,125 FEET

- EXISTING OPERATIONAL MONITORING SITE
- PROPOSED OPERATIONAL SAMPLING SITE (LOCATION APPROXIMATE)
- ⊕ SWRR COMPLIANCE MONITORING WELLS
- ⊕ GCMP MONITORING WELLS
- ⊕ SURFACE SEEP
- ⊕ TUNNELS
- PROPOSED CUT-OFF WALL
- EXISTING CUT-OFF WALL
- PIPELINES
- NEW DETENTION BASINS
- EXISTING SOUTH WASTE ROCK FOOTPRINT
- APPROXIMATE EXTENT OF SOUTH WASTE ROCK EXTENSION OVERLAYING PREVIOUSLY UNDISTURBED LAND

2.0 Operational Monitoring

Operational monitoring is intended to provide pertinent information regarding the proper functionality of the collection system as described in Attachment 2 of the SWRR Groundwater Discharge Permit Modification Application, to ensure that KUC meets permit conditions, and to verify impacts to groundwater. Actions that will be conducted to ensure that the system is functional and compliant with operational and regulatory criteria include the following:

- Inspecting and maintaining detention basins and associated storm water and sediment control structures
- Inspecting and maintaining cut-off walls and associated ditches, pipelines, flumes, and flow monitoring equipment
- Monitoring flows and water quality parameters associated with each of the drainages
- Monitoring seeps, including flow and water quality, and making system adjustments to capture seep flow as necessary

An integral part of maintaining BAT is preventive maintenance; which includes routine scheduled inspection and maintenance of the water collection system, documentation and adequate employee training.

2.1 Source Monitoring

Source monitoring is conducted at various locations that correlate with the water collection system and provides a characterization of water emanating from the toe of the waste rock dump reporting to the various cut-off walls and flumes. These sites are referred to as Operational Surface Sites and are listed under the existing permit in Table E-1 of Appendix E. The sites are sampled semiannually for water quality and quarterly for volumetric flow.

Table 2-1 lists the operational surface sites impacted by the SWRR with replacement “in kind” sampling. Figure 2-1 illustrates the existing and new surface monitoring locations. Site numbering will be established through the GCMP protocols upon permit modification approval.

TABLE 2-1
 Operational Sampling Sites

Sample ID	NAD 83		Existing Cut-off Wall	New Cut-off Wall (relocated)
	Latitude (dd)	Longitude (dd)		
ECP2616	40.5137981	-112.1152069	Yosemite	Yosemite (lower)
ECP2605	40.4956904	-112.125681	Butterfield 1	Butterfield 1
ECP2603	40.4935162	-112.1294315	Olsen	Olsen

Note: Sample identification numbers are generated in accordance with the GCMP

2.1.1 Tunnels

One tunnel exists within close proximity of the SWRR project area (Butterfield Tunnel). Water draining from the tunnel is sampled semi-annually for water quality, and monitored quarterly for flow. No changes to the tunnel are planned as part of the proposed modification. Tunnel information is included in Table 2-2.

TABLE 2-2
 Tunnels within the SWRR Project Area

Source ID	Description	Latitude	Longitude	Status After Modification
UPD010	Butterfield Tunnel at Weir	40.489714	-112.122942	No change

2.1.2 Seeps

Currently, one seep occurs along the BCM SWRR area. Water quality sampling and flow rate measurement is performed for this seep on a semi-annual basis. The location, water quality, and flow rate of the seep may change as a result of the SWRR.

KUC will continue to assess the collection system area for seeps on a quarterly basis. Seeps above the water collection system will be connected to the collection system as described in Attachment 2 of the SWRR Groundwater Discharge Permit Modification Application, thereby minimizing the release of WRCW to the principal aquifer. Water samples will continue to be collected and analyzed for pH and conductivity for seeps downstream of the water collection system. Any seep that has a measured pH less than 4.5 and conductivity greater than 5,000 micromhos per centimeter will be managed according to Appendix A of the *Groundwater Discharge Permit No. UGW350010* (DWQ, 2010). Existing seeps are listed in Table 2-3.

TABLE 2-3
 Seeps Within the SWRR Project Area

Source ID	Description	Latitude	Longitude	Status After Modification
ECS2715	Seep down gradient of existing Butterfield 1 cut-off wall	40.495314	-112.122731	This seep will flow to new Butterfield 1 cut-off wall.

2.1.3 Vadose Zone Monitoring

As described in Attachment 2, Groundwater Discharge Control Plan, the French drains and cut-off walls intersect all likely contact of WRCW with the vadose zone in the SWRR area. Therefore no vadose zone monitoring is planned.

2.1.4 Inspections

Inspections of the newly proposed Operational Sample Sites associated with the water collection system will be performed consistent with Appendix A of *Groundwater Discharge Permit No. UGW350010* (DWQ, 2010).

THIS PAGE INTENTIONALLY LEFT BLANK

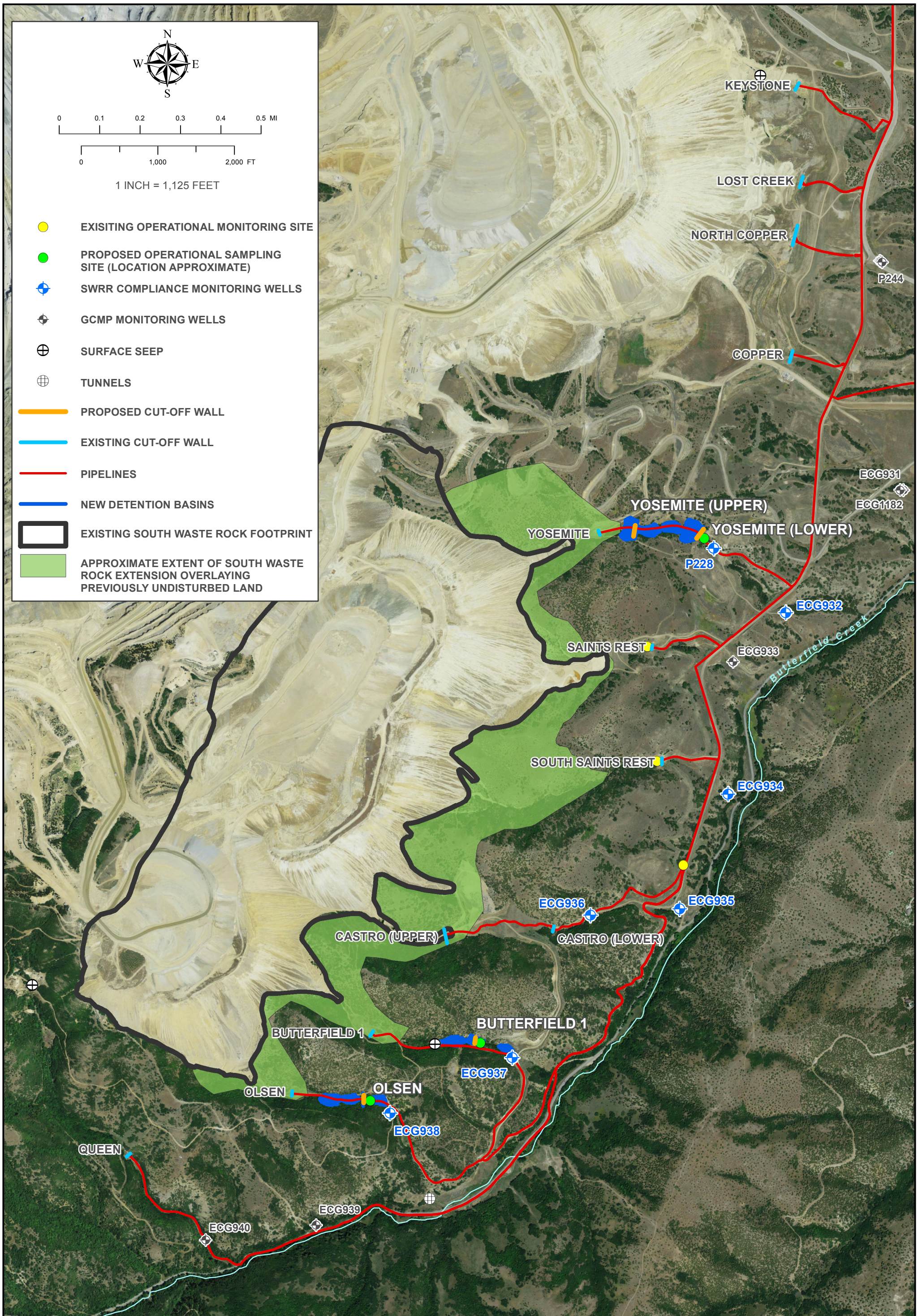

N
W E
S

0 0.1 0.2 0.3 0.4 0.5 MI
0 1,000 2,000 FT
1 INCH = 1,125 FEET

- EXISTING OPERATIONAL MONITORING SITE
- PROPOSED OPERATIONAL SAMPLING SITE (LOCATION APPROXIMATE)
- ⊕ SWRR COMPLIANCE MONITORING WELLS
- ⊕ GCMP MONITORING WELLS
- ⊕ SURFACE SEEP
- ⊕ TUNNELS
- PROPOSED CUT-OFF WALL
- EXISTING CUT-OFF WALL
- PIPELINES
- NEW DETENTION BASINS
- EXISTING SOUTH WASTE ROCK FOOTPRINT
- APPROXIMATE EXTENT OF SOUTH WASTE ROCK EXTENSION OVERLAYING PREVIOUSLY UNDISTURBED LAND

3.0 Groundwater Monitoring Program

A monitoring well network of 43 wells is used for compliance monitoring of the ECS. Seven of the 43 compliance wells are located hydraulically down gradient of the drainages impacted by the SWRR project area as shown on Figure 1-1. At a minimum, these wells will continue to provide monitoring in each major drainage and are intended to provide early detection of a release along likely flow paths down gradient of the SWRR area.

The proposed modification will not impact any of the existing monitoring wells. The existing compliance monitoring wells in the SWRR project area and their status after the proposed modification is listed in Appendix A. Screened intervals and lithologies for all wells in the SWRR area are detailed in Table 4-2 of Attachment 1.

The key rationale for monitoring well placement for the permit application is summarized as follows:

- Wells are located at the first point down gradient of the ECS to directly monitor the aquifer.
- Monitoring wells are down gradient from all the WRCW generation, transport, and protection systems, including the cut-off walls, canal, pipes, and the storm water collection system. Thus the compliance monitoring wells provide monitoring of potential releases of WRCW from the system controls designed to protect the principal aquifer.
- The location of the compliance monitoring wells down gradient of SWRR provides the opportunity for remedial responses in the event of an exceedance of the standards set for the compliance monitoring wells, prior to impacted water reaching the southwest Jordan Valley principal aquifer.

A more specific list of monitoring well siting criteria can be found in Sections 3.4.1 and 3.4.2 of the *Eastside Collection Monitoring System Ground Water Discharge Revision 1* and are summarized as follows:

- Incorporate long screen intervals when possible to guarantee the well intersects any contaminated water that passes through bedrock
- The screened interval is intended to cover the upper portion of the saturated bedrock aquifer from the water table
- One well per drainage will be provided as a compliance monitoring well
- Reasonable all-weather access to the location will be maintained

THIS PAGE INTENTIONALLY LEFT BLANK

4.0 Other Specific Requirements

Water sampling and monitoring will be performed using the methods for sampling, analyses, and quality control specified in the GCMP. Compliance limits for wells down gradient of the SWRR area are shown in Appendix C.

If new compliance monitoring wells are added to the permit in the future, compliance limits will be established as prescribed in the existing permit.

If new wells are constructed in the future, guidance approved in the United States Environmental Protection Agency (EPA) *Resource Conservation and Recovery Act Groundwater Monitoring Technical Enforcement Guidance Document* (1986) will be followed. Lithologic logs and well construction data for the new monitoring well will be provided in accordance with permit requirements. Any exceedances of permit requirements will be handled according to Part 1, Sections G and H, of *Groundwater Discharge Permit No. UGW350010* (DWQ, 2010). Corrective actions will follow the procedures outlined in Appendix C of *Groundwater Discharge Permit No. UGW350010* (DWQ, 2010), titled Contingency and Correction Action Plan.

THIS PAGE INTENTIONALLY LEFT BLANK

5.0 References

Kennecott Utah Copper (KUC). 1994. *Eastside Collection Monitoring System Ground Water Discharge Revision 1*. June.

Kennecott Utah Copper (KUC). 2014. *Groundwater Characterization and Monitoring Plan*. September.

United States Environmental Protection Agency (EPA). 1986. *Resource Conservation and Recovery Act Groundwater Monitoring Technical Enforcement Guidance Document*.

Utah Department of Environmental Quality, Division of Water Quality (DWQ). 2010. *Ground Water Discharge Permit No. UGW350010*. March.

THIS PAGE INTENTIONALLY LEFT BLANK

Appendix A
Existing SWRR Compliance Monitoring Wells
and Status after the Proposed Modification

THIS PAGE INTENTIONALLY LEFT BLANK

APPENDIX A

Existing SWRR Compliance Monitoring Wells and Status After the Proposed Modification

Well ID	Location	Longitude	Latitude	Completion Lithology	Monitoring Frequency	Status After Modification*
VWP228	Yosemite drainage	-112.110611	40.513692	Alluvium	Quarterly	A
ECG932	Yosemite drainage	-112.106386	40.510844	Bedrock	Semiannual	A
ECG934	South Saints Rest drainage	-112.109028	40.504369	Bedrock	Semiannually	A
ECG935	Castro drainage	-112.111263	40.500235	Bedrock	Semiannually	A
ECG936	Castro drainage	-112.115456	40.499979	Bedrock	Semiannually	A
ECG937	Butterfield 1 drainage	-112.119090	40.494483	Bedrock	Semiannually	A
ECG938	Olsen drainage	-112.124032	40.492896	Bedrock	Semiannually	A

NOTES:

Only compliance or proposed compliance wells associated with the South Waste Rock Reclamation (SWRR) modification area are included in this table.

*** STATUS:**

(A) No change; monitoring well is not affected by either the dump footprint or collection system modification

THIS PAGE INTENTIONALLY LEFT BLANK

Appendix B
SWRR Compliance Well Permit Limits

THIS PAGE INTENTIONALLY LEFT BLANK

APPENDIX B
SWRR Compliance Well Permit Limits (units of mg/L and pH standard units)

Well ID	Location	Longitude	Latitude	Completion Lithology	Monitoring Frequency	pH	TDS	SO ₄	Dissolved Cd	Dissolved Cu	Dissolved Zn
VWP228	Yosemite drainage	-112.110611	40.513692	Alluvium	Quarterly	5.5-8.5	11,173	7,721	0.064	0.65	4.74
ECG932	Yosemite drainage	-112.106386	40.510844	Bedrock	Semiannual	6.5-8.5	796	164	0.001	0.325	1.25
ECG934	South Saints Rest drainage	-112.109028	40.504369	Bedrock	Semiannual	6.5-8.5	1,157	449	0.001	0.325	1.25
ECG935	Castro	-112.111263	40.500235	Bedrock	Semiannual	6.47-8.5	4,771	2,794	0.003	0.650	2.50
ECG936	Castro	-112.115456	40.499979	Bedrock	Semiannual	6.36-8.5	5,159	3,160	0.003	0.650	2.50
ECG937	Butterfield 1	-112.119090	40.494483	Bedrock	Semiannual	6.5-8.5	1,359	476	0.001	0.325	1.25
ECG938	Olsen	-112.124032	40.492896	Bedrock	Semiannual	6.5-8.5	1,016	266	0.001	0.325	1.25

NOTES:

¹ Sampling has already occurred quarterly in 2013 to provide data from which to establish compliance limits.

- TDS compliance limits are calculated as 1.25 times the background concentration for Class II and Class III groundwater.
- For many wells, Cd, Cu, and Zn were predominantly non-detects; compliance limits are therefore determined from the groundwater quality standard.
- Where the background concentrations is < detection, compliance limits are based on 0.25 times the ground water quality standard for Class II groundwater and 0.50 times the groundwater quality standard for Class III groundwater for Cd, Cu, and Zn.
- If background value exceeds the groundwater quality standard, the Protection Level equals the background value.
- The Compliance Limits for Class IV groundwater are the higher of the groundwater quality standard, the mean *1.25, or the mean+2 std. dev.
- There is not a groundwater quality standard for SO₄; compliance limits for sulfate were calculated as the higher of the mean+2 std. dev. or 1.25 times the mean.
- Range of pH values for compliance limits are based on the higher and lower limit of 6.5 to 8.5 and/or mean + and - 2 std. dev.
- Limits were set using all available data for each individual well through 2011.

Cd = cadmium

Cu = copper

SO₄ = sulfate

TDS = total dissolved

Zn = zinc

THIS PAGE INTENTIONALLY LEFT BLANK